



Instruction Manual



Senator LS Series Air Compressor Sets with MAM-870 Controller

Revision: 2024-10-25



Introduction

Thank-you and congratulations for purchasing a high quality Senator air compressor set. It has been designed and manufactured to provide many years of safe and reliable service if installed, operated and maintained in accordance with these instructions.

Please read and understand this manual before operating the compressor. Failure to do so could result in death, severe injury and / or substantial property damage. This manual should be considered a permanent part of the compressor and should remain with it if resold.

Disclaimers

All information, illustrations and specifications in this manual are based on the latest information available at the time of publishing. The illustrations are intended as representative reference views only. Due to our policy of continuous product improvement, we may modify information, illustrations and / or specifications to explain and / or exemplify a product, service or maintenance improvement.

We reserve the right to make any change at any time without notice. Your compressor may differ slightly from models pictured, including optional accessories.

All Rights Reserved

No part of this publication may be reproduced or used in any form by any means – graphic, electronic or mechanical, including photocopying, recording, taping or information storage and retrieval systems – without the written permission of Glenco Air & Power Pty Ltd.

Contents

1.0	Safety	1
2.0	Specifications	3
3.0	Product Description	6
4.0	Installation	11
5.0	Operation	14
6.0	Maintenance	20
7.0	Fault Diagnosis and Repair	29
8.0	Warranty	32
Appendix A	MAM-870 Controller	34
Appendix B	Remote Start and Stop Control	51
Appendix C	Sequential Control	53

1.0 Safety

The air compressor should only be operated by authorised persons. All users should follow the instructions and safety warnings as (a) described in this instruction manual, (b) shown on any decals affixed to the unit and (c) described in the Plant Risk Assessment also available from the manufacturer.

All users of the compressor and any other workers likely to be in the vicinity thereof should undergo training to achieve the requisite minimum level of operator competence before placing the unit into service.

The compressor should be installed in a horizontal position on a firm, level and stationary foundation such as a concrete floor that is strong enough to support its weight. The unit should not impede pedestrian or vehicular traffic.

The compressor should be installed in a well-ventilated area preferably indoors. If it has to be located outdoors, the unit should be provided with weather protection against precipitation and direct sunlight

Do not locate the compressor where chemicals, dust, dirt, fibres, oil, salt, water or flammable / explosive liquids, gases or dusts may be present. The area should not be wet or damp. The unit should be kept away from other heat sources.

All electrical installation, maintenance or repair work should be performed by a licensed electrician.

The electricity supply circuit to the compressor should comply with the AS/NZS 3000:2007 Wiring Rules. It should include a fixed setting residual current device (RCD) with a rated operating residual current not exceeding 30 mA.

Do not use the unit to compress any gas other than air.

Compressed air can contain carbon monoxide, hydrocarbons and / or other poisonous contaminants that can cause death or serious injury. The compressor is not designed, intended or approved for breathing air. Do not use compressed air for breathing air applications without proper treatment.

Before operating the compressor, check the safety of any hoses, piping and pneumatic equipment connected to the discharge air outlet valve. Use only hoses, piping, fittings, air receivers, air tools, etc. connected to the compressor's discharge outlet valve that are safe for the unit's maximum discharge pressure (i.e. 1,000 kPa) and temperature (i.e. 100°C).

The compressor should not be operated beyond its specified design parameters, especially the maximum discharge pressure. Do not bypass or disable any of the unit's safety features.

Do not modify the compressor without written permission from the manufacturer.

Do not operate the compressor with any of its maintenance access panels open or removed.

Do not direct a compressed air discharge stream onto a person's body.

Monitor the compressor and downstream compressed air system for any excessive noise / vibration, leaks or other abnormalities and repair any faults immediately.

Before performing any maintenance work on the compressor, switch off the unit, isolate and tag-out the power supply, carefully release any residual air pressure from the internal air-oil receiver and any connected downstream piping in the user's network, and close the air outlet valve. And if possible, allow the unit to cool down if it's been running.

During maintenance work, take care to prevent any body parts, clothing or tools from touching any hot or moving components inside the compressor cabinet.

The maintenance access panels should be handled as a two-person lift and stored in a horizontal position when removed.

Carry out preventative maintenance on the compressor in accordance with the recommended schedule using only genuine spare parts.

Clean up any oil leak discharge or oil spill immediately.

Drain condensate from the air-oil receiver only when it is depressurised. Monitor the drained condensate to check whether it poses a slip hazard, e.g. excessive condensate discharged onto a smooth, non-porous floor.

Clothing sleeves should be tight fitting, long hair should be tied back, jewellery and other loose articles should be removed, and loose gloves should not be worn when operating or maintaining the compressor.

Wear body protection such as tight-fitting gloves, long sleeves and safety boots and also eye protection such as glasses when performing any maintenance work on the compressor.

Wear eye protection such as glasses if working close to pressurised compressed air plant.

Wear protection such as a filter respirator and goggles when blowing down with compressed air. Minimise the generation of dust by compressed air blowing.

Wear appropriate eye, respiratory and body protection when spraying paint or other chemicals with compressed air. Refer to the chemical's MSDS for specific personal protective equipment (PPE) recommendations.

2.0 Specifications

Compressor Model	LS18	LS22	
Air Discharge (m ³ /min) @ 7 bar @ 8 bar @ 10 bar	3.28	3.93	
	3.08	3.58	
	2.73	3.20	
Air Discharge Temperature (°C)	≤ Ambient + 15		
Oil Content in Discharge Air (ppm)	≤ 3 w/w		
Lubricating Oil Capacity (L)	≈ 16	≈ 16	
Ambient Design Conditions	0°C ≤ T ≤ 45°C, P = 101.325 kPa, RH ≤ 80%		
Driving Mode	Fixed Speed Electric Motor with V-Belt Drive		
Cooling Mode	Fan-Forced Oil Cooler and Air After-Cooler		
Motor Starting Mode	Star-Delta		
Temperature Control Mode	Thermostatic Valve		
Input Power Supply (V / Ph / Hz)	415 / 3 / 50		
Input Power Supply (A) @ Rated PF	≈ 37.8	≈ 44.6	
Main Motor Power (kW / hp)	18.5 / 25	22 / 30	
Main Motor Speed (rpm)	2,930	2,940	
Protection: Main Motor	IP55		
Fan Motor Power / Speed (kW / rpm)	0.25 / 930	0.25 / 930	
Protection: Fan Motor	IP54		
Protection: Compressor Cabinet	IP43 with cabinet doors closed. Designed for stationary use only located either indoors or outdoors with weather protection against precipitation and direct sunlight.		
Protection: Internal Elec. Cabinet	IP22		
Noise Level @ 1 m (dB(A))	70	71	
Discharge Air Pipe Connection	1" BSP Female	1" BSP Female	
Air-Oil Receiver Volume (L)	27	27	
Overall Dimensions: W × D × H (cm)	125 × 90 × 142	125 × 90 × 142	
Weight (kg)	562	636	
Air End Pulley: Type × PCD × Grooves	7 bar	SPA × 160 × 3	SPA × 155 × 3 *
	8 bar	SPA × 170 × 3	SPA × 150 × 3
	10 bar	SPA × 170 × 3	SPA × 170 × 3
Air End Pulley Taper Bush: Model × Bore	7 bar	2517 × 45	2517 × 45
	8 bar	2517 × 45	2517 × 45
	10 bar	2517 × 45	2517 × 45
Motor Pulley: Type × PCD × Grooves	7 bar	SPA × 150 × 3	SPA × 170 × 3
	8 bar	SPA × 150 × 3	SPA × 155 × 3 *
	10 bar	SPA × 132 × 3	SPA × 155 × 3 *
Motor Pulley Taper Bush: Model × Bore	7 bar	2517 × 42	2517 × 48
	8 bar	2517 × 42	2517 × 48
	10 bar	2012 × 42	2517 × 48
V-Belts: Quantity × Type-Size	7 bar	3 × SPA-1357	3 × SPA-1382
	8 bar	3 × SPA-1357	3 × SPA-1357
	10 bar	3 × SPA-1332	3 × SPA-1382

* Proprietary pulley design, not commercial off-the-shelf type.

Compressor Model	LS30	LS37	LS45
Air Discharge (m ³ /min) @ 7 bar @ 8 bar @ 10 bar	5.21	6.80	7.79
	4.96	6.38	7.18
	4.38	5.67	6.38
Air Discharge Temperature (°C)	≤ Ambient + 15		
Oil Content in Discharge Air (ppm)	≤ 3 w/w		
Lubricating Oil Capacity (L)	≈ 30	≈ 30	≈ 30
Ambient Design Conditions	0°C ≤ T ≤ 45°C, P = 101.325 kPa, RH ≤ 80%		
Driving Mode	Fixed Speed Electric Motor with V-Belt Drive		
Cooling Mode	Fan-Forced Oil Cooler and Air After-Cooler		
Motor Starting Mode	Star-Delta		
Temperature Control Mode	Thermostatic Valve		
Input Power Supply (V / Ph / Hz)	415 / 3 / 50		
Input Power Supply (A) @ Rated PF	≈ 60.5	≈ 73.2	≈ 88.2
Main Motor Power (kW / hp)	30 / 40	37 / 50	45 / 60
Main Motor Speed (rpm)	2,940	2,940	2,960
Protection: Main Motor	IP55		
Fan Motor Power / Speed (kW / rpm)	0.37 / 930	0.37 / 930	0.37 / 930
Protection: Fan Motor	IP54		
Protection: Compressor Cabinet	IP43 with cabinet doors closed. Designed for stationary use only located either indoors or outdoors with weather protection against precipitation and direct sunlight.		
Protection: Internal Elec. Cabinet	IP22		
Noise Level @ 1 m (dB(A))	71	72	73
Discharge Air Pipe Connection	1½" BSP Female	1½" BSP Female	1½" BSP Female
Air-Oil Receiver Volume (L)	54	54	54
Overall Dimensions: W × D × H (cm)	146 × 102 × 169	146 × 102 × 169	146 × 102 × 169
Weight (kg)	900	916	969
Air End Pulley: 7 bar Type × PCD × Grooves 8 bar 10 bar	SPA × 224 × 4 SPA × 224 × 4 SPA × 224 × 4	SPA × 170 × 4 SPA × 180 × 4 SPA × 180 × 4	SPA × 170 × 4 SPA × 180 × 4 SPA × 180 × 4
Air End Pulley Taper Bush: 7 bar Model × Bore 8 bar 10 bar	3020 × 50 3020 × 50 3020 × 50	2517 × 50 2517 × 50 2517 × 50	2517 × 50 2517 × 50 2517 × 50
Motor Pulley: 7 bar Type × PCD × Grooves 8 bar 10 bar	SPA × 190 × 4 SPA × 180 × 4 SPA × 160 × 4	SPA × 190 × 4 SPA × 190 × 4 SPA × 170 × 4	SPA × 224 × 4 SPA × 224 × 4 SPA × 200 × 4
Motor Pulley Taper Bush: 7 bar Model × Bore 8 bar 10 bar	2517 × 55 2517 × 55 2517 × 55	2517 × 55 2517 × 55 2517 × 55	3020 × 55 3020 × 55 3020 × 55
V-Belts: 7 bar Quantity × Type-Size 8 bar 10 bar	4 × SPA-1657 4 × SPA-1657 4 × SPA-1657	4 × SPA-1632 4 × SPA-1632 4 × SPA-1607	4 × SPA-1657 4 × SPA-1657 4 × SPA-1632

Compressor Model	LS55	LS75	
Air Discharge (m ³ /min) @ 7 bar @ 8 bar @ 10 bar	10.30	13.05	
	9.58	12.33	
	9.04	11.18	
Air Discharge Temperature (°C)	≤ Ambient + 15		
Oil Content in Discharge Air (ppm)	≤ 3 w/w		
Lubricating Oil Capacity (L)	≈ 50	≈ 50	
Ambient Design Conditions	0°C ≤ T ≤ 45°C, P = 101.325 kPa, RH ≤ 80%		
Driving Mode	Fixed Speed Electric Motor with V-Belt Drive		
Cooling Mode	Fan-Forced Oil Cooler and Air After-Cooler		
Motor Starting Mode	Star-Delta		
Temperature Control Mode	Thermostatic Valve		
Input Power Supply (V / Ph / Hz)	415 / 3 / 50		
Input Power Supply (A) @ Rated PF	≈ 108	≈ 144	
Main Motor Power (kW / hp)	55 / 75	75 / 100	
Main Motor Speed (rpm)	2,960	2,960	
Protection: Main Motor	IP55		
Fan Motor Power / Speed (kW / rpm)	0.55 / 955	1.1 / 910	
Protection: Fan Motor	IP54	IP55	
Protection: Compressor Cabinet	IP43 with cabinet doors closed. Designed for stationary use only located either indoors or outdoors with weather protection against precipitation and direct sunlight.		
Protection: Internal Elec. Cabinet	IP22		
Noise Level @ 1 m (dB(A))	73	74	
Discharge Air Pipe Connection	2" BSP Female	2" BSP Female	
Air-Oil Receiver Volume (L)	100	100	
Overall Dimensions: W × D × H (cm)	179 × 125 × 190	179 × 125 × 190	
Weight (kg)	1,419	1,579	
Air End Pulley: Type × PCD × Grooves	7 bar 8 bar 10 bar	SPB × 190 × 6 SPB × 200 × 6 SPB × 200 × 6	SPB × 180 × 6 SPB × 190 × 6 SPB × 200 × 6
Air End Pulley Taper Bush: Model × Bore	7 bar 8 bar 10 bar	3020 × 55 3020 × 55 3020 × 55	3020 × 55 3020 × 55 3020 × 55
Motor Pulley: Type × PCD × Grooves	7 bar 8 bar 10 bar	SPB × 160 × 6 SPB × 160 × 6 SPB × 150 × 6	SPB × 200 × 6 SPB × 200 × 6 SPB × 190 × 6
Motor Pulley Taper Bush: Model × Bore	7 bar 8 bar 10 bar	3020 × 60 3020 × 60 2517 × 60	3020 × 65 3020 × 65 3020 × 65
V-Belts: Quantity × Type-Size	7 bar 8 bar 10 bar	6 × SPB-1800 6 × SPB-1800 6 × SPB-1800	6 × SPB-1850 6 × SPB-1850 6 × SPB-1850

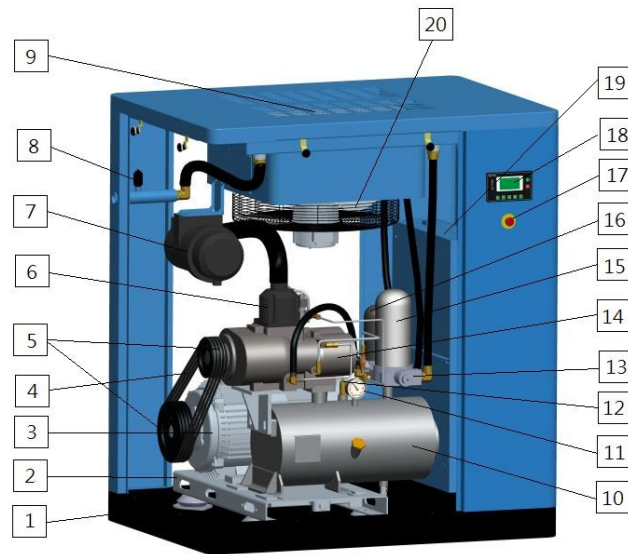

1. Baseframe	2. Baseplate	3. Motor	4. V-Belts
5. Pulleys	6. Inlet Valve	7. Air Filter	8. Pressure Sensor
9. Cooler	10. Air-Oil Receiver	11. Pressure Gauge	12. Safety Valve
13. Combination Valve	14. Air End	15. Air-Oil Separator	16. Oil Filter
17. Emergency Stop	18. Controller	19. Electrical Cabinet	20. Cooling Fan

Figure 3-2 Structure of a LS Series Air Compressor Set

3.2.1 Air System

Ambient air is drawn in via the air filter and flows through the inlet valve into the rotary screw air end for compression. Oil is continuously injected into the air end to provide both lubrication and cooling. The compressed air and oil mixture flows into the air-oil receiver for preliminary separation and then into the air-oil separator. After the air and oil are separated, the compressed air flows through the minimum pressure valve, then the after-cooler and is finally discharged into the pipeline network of the user.

The function of the air filter is to remove any particulate matter such as dirt and dust to ensure that only clean air enters into the compressor's screw air end. The inlet valve is kept fully open whenever the compressor is in "loading" mode, whereby it is pumping compressed air into the air receiver. If the discharge air pressure rises to a pre-programmed maximum, the compressor enters "unloading" mode whereupon the inlet valve closes fully to stop any further air being delivered into the user's network.

The inlet valve is also kept closed during compressor start-up to reduce load on the main motor. When the unit is shut down, the inlet valve is closed to prevent compressed air and oil flowing backwards from the air-oil receiver and being ejected through the air inlet.

The minimum pressure valve ensures that the pressure in the air-oil receiver doesn't fall below 0.35 MPa when the compressor is running so that the lubricating oil can flow normally in the system. When the compressor is running in unloading mode or shut down, the minimum pressure valve prevents the compressed air in the pipeline network of the user from flowing

backwards into the unit.

An automatic vent valve is located beside the inlet valve. The vent valve automatically opens to release air pressure from the air-oil receiver whenever the compressor is in unloading mode or shut down.

3.2.2 Lubrication System

The compressed air and oil mixture is injected into the air-oil receiver and collides with its inner wall. Most of the lubricating oil is separated from the air-oil mixture during this process and accumulates in the lower part of the air-oil receiver. The remaining oil is captured by the air-oil separator and transferred back to the screw air end via the oil return pipe.

During compressor operation, when the temperature of the lubricating oil is below 71°C the thermostatic valve automatically opens the bypass circuit and the circulating oil from the air-oil receiver is directly injected under air pressure into the screw air end and individual lubricating points via the oil system piping and oil filter. When the temperature rises above 71°C, the thermostatic valve gradually shuts off the bypass circuit and simultaneously opens the circuit going to the oil cooler. If the temperature rises to 85°C, the bypass circuit is completely shut off and the entire lubricating oil flow from the air-oil receiver is passed through the oil cooler circuit on its way back to the air end.

The functions of the thermostatic valve are to (a) maintain constant temperature and viscosity of lubricating oil, (b) enable the system to reach the optimal operating temperature as soon as possible and (c) maintain sufficient temperature to prevent water vapour in the system from condensing. The function of the lubricating oil filter is to remove any metal wear particles and lubricating oil cracking products so as to minimise wear of the air end bearings and rotors.

3.2.3 Cooling System

Cooling air is drawn from outside the unit by the cooling fan and then blown across the radiator fins of the combined oil cooler and air after-cooler. Heat exchange takes place between the cooling air and the hot oil and compressed air streams to achieve a cooling effect. The maximum ambient air temperature should not exceed 45°C otherwise excessively high compressed air and oil temperatures will occur; this will shorten the life of the lubricating oil and may activate over-temperature shutdown of the compressor.

3.3 Control Protection System

The compressor has a micro-computer controller which automatically adjusts the operating state of the unit according to the actual air consumption of the user's application.

If the air consumption is low or the air application is paused, the inlet valve will close allowing the compressor to operate with reduced energy consumption in unloading mode. After the air consumption is recommenced, the controller opens the inlet valve again to enable the compressor to operate normally in loading mode. The controller monitors the compressor at all times when it's running. If any abnormal condition – such as motor overload, air discharge over-temperature, etc. – is detected, the controller automatically shuts down the compressor to protect it against damage.

A safety valve is installed in the air-oil receiver. If the pressure inside the receiver exceeds its design rating, the safety valve will automatically open to quickly discharge the air and reduce the pressure, thereby ensuring safety of the unit and personnel. The safety valve should not open during normal operation.

3.4 Electrical System

The electrical system consists primarily of the main motor, fan motor, electrical control cabinet assembly, solenoid valve, temperature sensor, pressure sensor and controller.

To protect the main and fan motors against overheating damage due to abnormal conditions, their operating current draws are monitored by the controller. If the motor current exceeds the allowable current, the compressor controller will perform an immediate shutdown and the motor overload alarm message will be shown on the controller's display panel.

The electrical schematic diagram is shown in Fig 3-3.

3.5 Compressor Controller and Operation Panel

The compressor is fitted with an advanced micro-computer controller with built-in user interface. The controller handles the automatic operation, monitoring and protection of the compressor's functions.

To ensure normal and safe operation of the compressor, users should be familiar with the functions and meanings of the individual buttons, display messages and indicating lights on the controller. Please refer to the separate MAM-870 Controller Instruction Manual in Appendix A for complete details.

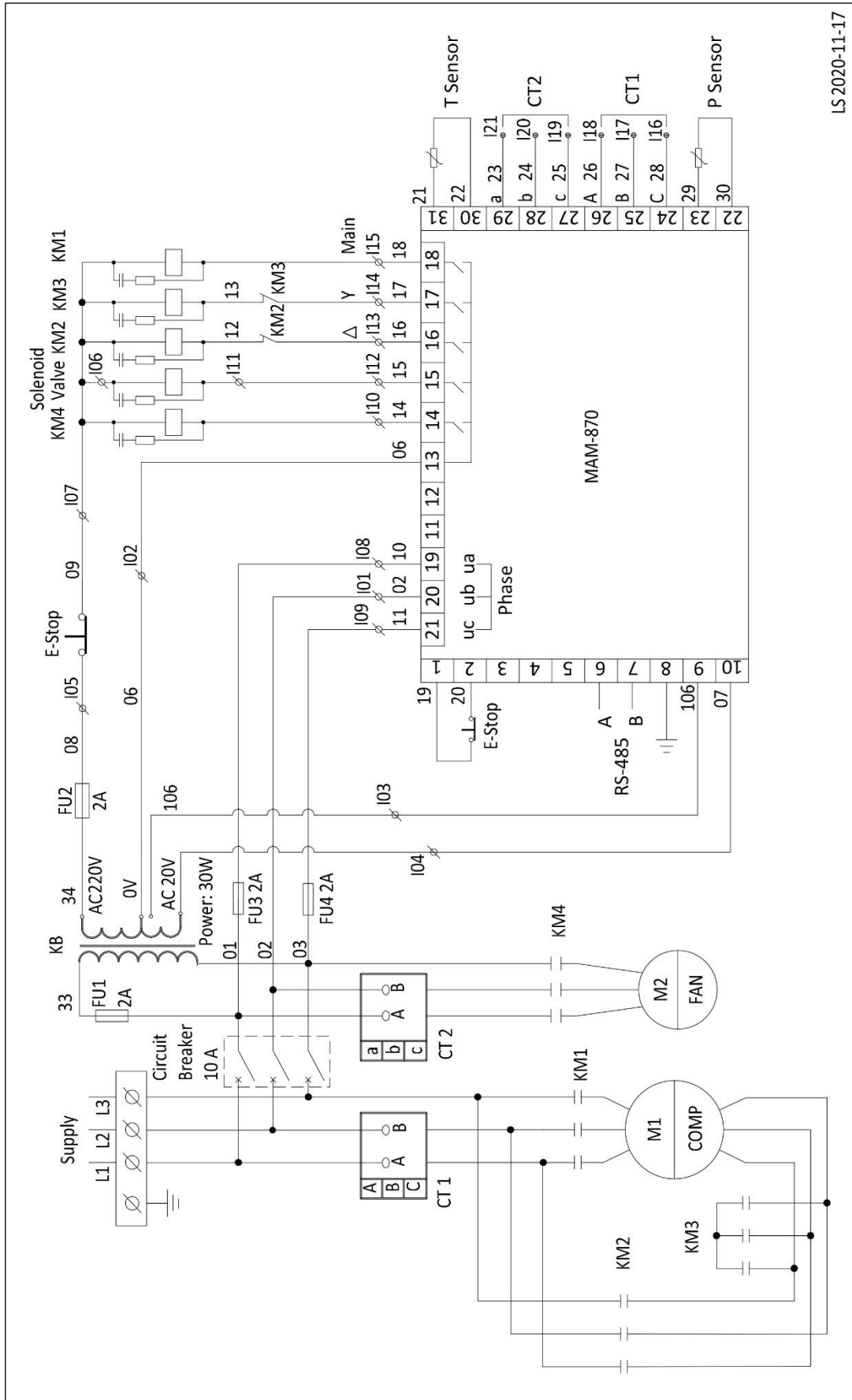

LS 2020-11-17

Figure 3-3 Electrical Schematic Diagram of LS Series

4.0 Installation

4.1 Outline Dimensions

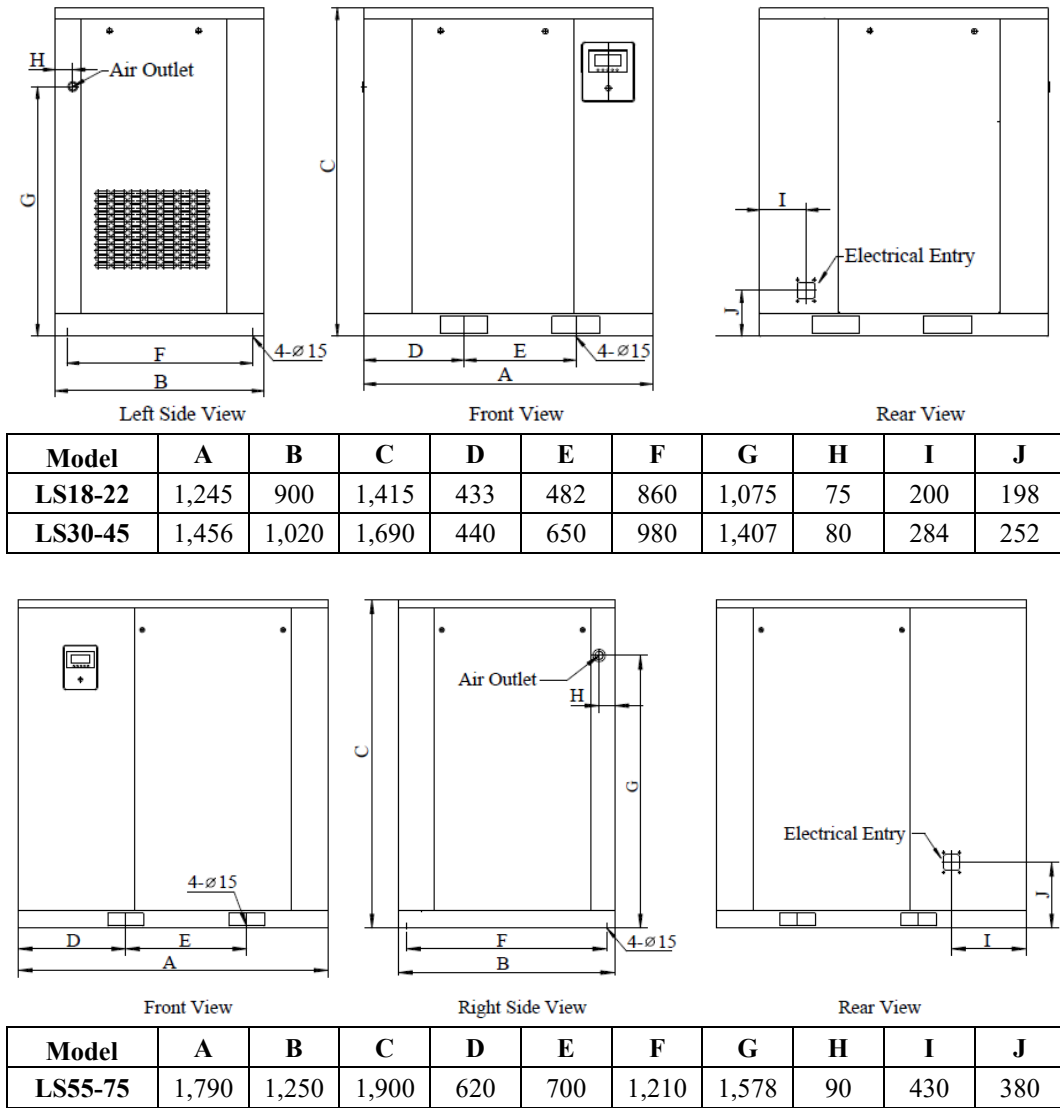

Figure 4-1 Outline Dimensions of LS Series (in mm)

4.2 Installation Site of Compressor

A proper installation site should be selected for the compressor. It is recommended to use a dedicated compressor room. The installation site should meet the following requirements:

- a. It is essential to install the compressor in an area with good lighting and sufficient free space for unhindered operation and maintenance. The compressor should have clearance of no less than 0.6 m around all four sides. The ceiling height should be at least 2.4 m from floor level.

- b. Good ventilation is essential to ensure that the indoor ambient temperature is kept to a minimum; it should never exceed 45°C. If the compressor room is mechanically ventilated, the cooling airflow should be at least 750 m³/h per kW of nominal compressor motor power. Thus, the requisite cooling airflow to suit a LS37 compressor, for example, would be at least $37 \times 750 = 27,750 \text{ m}^3/\text{h}$.
- c. The ambient air should be reasonably clean and free of solid and gaseous contamination. It should have low relative humidity, low dust content and no corrosive, explosive or inflammable substances present. If the air quality fails to reach these requirements, it will be necessary to provide clean air entry to the compressor room from a remote source or install pre-filtration equipment.
- d. The compressor should be installed in a horizontal position on a solid, flat foundation. Mounting holes are provided in the compressor’s baseframe through which it should be affixed to the floor with hold-down fasteners. The unit is designed for stationary duty only.
- e. If it has to be located outdoors, the compressor should be provided with weather protection against precipitation and direct sunlight.

4.3 Electricity Supply

Air Compressor Model	Main Motor Rating (kW)	Main Motor Starting Method	Maximum Running Current (A)	Minimum Circuit Breaker Rating (A)	Circuit Breaker Tripping Curve
LS18	18.5	Star-Delta	37.8	50	C or D
LS22	22	Star-Delta	44.6	63	C or D
LS30	30	Star-Delta	60.5	80	C or D
LS37	37	Star-Delta	73.2	100	C or D
LS45	45	Star-Delta	88.2	125	C or D
LS55	55	Star-Delta	108	160	C or D
LS75	75	Star-Delta	144	200	C or D

- a. The compressor requires a three-phase mains power supply stabilised at 415 Volts and 50 Hertz. A portable electric generator is not recommended for powering the compressor unless it has ample generating capacity to supply both the requisite starting and running current demands without appreciable voltage or frequency drop.
- b. All electrical installation work must be performed by a licensed electrician in accordance with the AS/NZS 3000:2007 Wiring Rules.
- c. A separate electricity supply circuit is recommended for the compressor to avoid motor current overload due to excessive voltage drop or an unbalanced three-phase condition caused by other electrical equipment operating in parallel.
- d. For additional protection against electric shock, it is recommended to include a fixed setting

residual current device (RCD) with rated operating residual current not exceeding 30 mA. Special RCDs should be considered for use with high current or variable speed drives (VSDs) to prevent nuisance tripping.

- e. The circuit breaker information provided in the table above is a general guide only for dedicated supply to the compressor. A four-wire conductor is required for the electricity supply, i.e. three-phase and earth only (no neutral).
- f. The maximum running current may exceed the specified value in practice if the electricity supply voltage and / or power factor are below their rated levels.
- g. If the initially connected phase sequence is incorrect, the compressor's controller will announce a "PHASE REVERSE" failure. The direction of air end rotation should also be double-checked during installation by performing a "bump" test with reference to the direction-of-rotation arrow marked permanently on the air end.

5.0 Operation

Before compressor start-up, the operator should thoroughly read and understand this manual and familiarise him or her-self with the compressor's features. The operator should comply with all of the instructions and especially the safety notices.

5.1 Initial Start-Up

- a. Remove the compressor from its timber crate and shipping skid. Use a forklift only to lift the compressor by means of the fork blade pockets in the baseframe. Caution: The unit's centre-of-gravity is offset towards the left-hand side of models LS18-45 and the right-hand side of models LS55-75 when viewed looking onto the front (controller) side.
- b. Remove the two red shipping brackets attached between the baseframe and baseplate as shown in Figure 5-1.

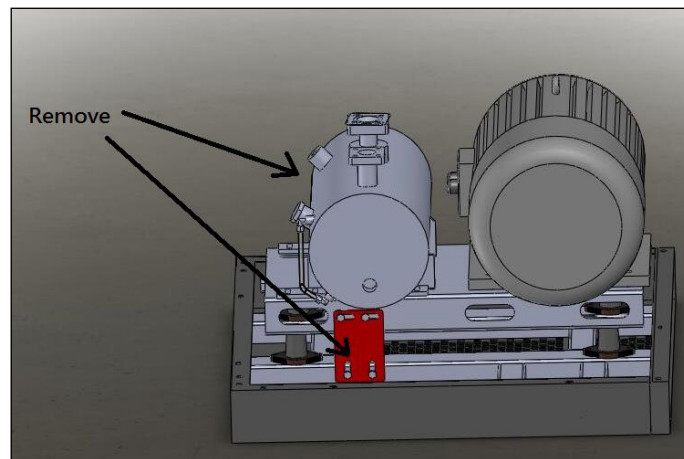



Figure 5-1 Shipping Brackets

- c. Connect the power supply cable and the earth cable (if separate). Check that the voltage is correct and equal on all three phases.
- d. Check whether the electrical wiring is safe, secure and reliable.
- e. Check whether the oil level in the air-oil receiver is OK.
- f. Check whether the V-belt tension is correct.
- g. Before start-up after three or more months of shutdown or storage, add about 0.5 L of clean compressor lubricating oil directly into the compressor through the air inlet valve and then rotate the screw air end for several turns by hand. This is to prevent friction / heat damage to the screw air end due to insufficient lubrication upon initial start-up.
- h. At the first power-on, the power supply indicator light on the control panel will be

illuminated and the current pressure in the air tank will be displayed on the control panel. If the phase sequence rotation of the power supply is incorrect, the controller will display “PHASE REVERSE”. A licensed electrician must then reverse the phase sequence rotation by interchanging any two phases of the power supply connection.

- i. Open the air outlet valve.
- j. Rotation direction test: Although the compressor has built-in reverse phase sequence protection, the rotation direction test is still an important step in the initial start-up. It should also be carried out whenever the motor is repaired or replaced.
- k. Press the Start button  and then immediately press the Emergency Stop button when the motor shaft begins to rotate. Make sure that the rotation direction of the motor is consistent with the direction arrow marked on the air end. If it is incorrect, the phase rotation sequence of the power supply must be reversed by a licensed electrician. The rotation direction of the fan motor should also be checked; the cooling air should discharge through the oil cooler / air after-cooler and upwards from the exhaust vents on top of the unit. After completing these checks and making any necessary adjustments, release the Emergency Stop button by turning it clockwise.
- l. Re-start the compressor. The unit will automatically commence operating. Stop or limit any downstream compressed air use so that the system pressure can rise until the unit switches to unloading mode. Check whether the unloading pressure is consistent with the pre-programmed setting and observe whether the controller shows all monitored parameters are within their normal ranges. If any abnormal sound, vibration or leakage occurs, immediately press the Emergency Stop button to shut down the machine for inspection.
- m. Shutdown: Press the Stop button . The unit will enter the unloading mode and the compressor vent valve will discharge the internal system air. After 30 seconds, the unit will stop. During normal operation, do not use the Emergency Stop button to shut down the compressor.

5.2 Daily Operation

5.2.1 Start-Up

- a. Remove the plug and carefully open the ball valve at the bottom of the air-oil receiver to drain out any water condensate. Close the drain valve immediately when lubricating oil starts to flow out and then re-install the plug. This task should be undertaken when the unit is cold prior to use.

Caution: Ensure the air-oil receiver is not pressurised before removing the plug and opening the ball valve.

- b. Open the air outlet valve on the side of the compressor cabinet.
- c. Start-up any peripheral compressed air equipment such as an air dryer.
- d. Press the Start button  on the compressor.

- e. After the operation is in steady state, check the discharge pressure and temperature readings. The pressure should remain within the limits of the “loading” and “unloading” pressure settings provided that the compressor and / or the air storage capacity is large enough for the application. The temperature will typically vary between 71 and 85°C depending upon the unit’s operating conditions, and should not exceed 104°C.
- f. Ensure that the pre-maintenance safety precautions described in Section 1.0 are taken before checking the compressor’s oil level in accordance with the instructions given in Section 6.0.
- g. If any abnormal condition is found, turn off and isolate the compressor for inspection. Only re-start the unit after rectifying the problem.

5.2.2 Operating Modes

Starting

Press the Start button **I**. The contactor in the electrical cabinet will close to start the main drive motor. At this point, the throttle in the inlet valve will be closed, and only a low volume of air enters into the compressor through the check valve in the inlet valve. The compressor starts at reduced load and then the preliminary system pressure gradually increases in the air-oil receiver.

Loading

13 seconds after starting, the solenoid actuated inlet valve opens fully so that a high volume of air can enter into the compressor to enable “loading” mode operation. When the pressure inside the air-oil receiver reaches 0.35 MPa, the minimum pressure valve opens and the unit starts to discharge into the user’s compressed air system.

Unloading

If the user’s air consumption remains continuously below the compressor’s minimum discharge flowrate, the discharge pressure of the unit will reach the set unloading pressure. At this point, the inlet valve closes to stop air input. The check valve spool of the minimum pressure valve is closed to isolate the compressor from the pipeline of the user. The vent valve opens to reduce the pressure in the air-oil receiver down to approximately 0.4 MPa, thereby reducing the operating back pressure within the compressor’s air circuit and maintaining lubricating oil circulation.

In unloading mode, if the discharge pressure reduces to the loading pressure set point, the controller actuates the solenoid to open the inlet valve and close the vent valve. The unit is thus returned to the loading operation state.

If the unit fails to stop loading operation at the correct unloading set point pressure, it may cause the safety valve installed in the air-oil receiver to open for system pressure relief, thereby avoiding any hazard due to excessively high system pressure. If this occurs, immediately shut down the unit and check the inlet valve and controller for their correct operation and setting.

Stand-By



If the compressor operates continuously in unloading mode for five minutes, the controller assumes that the user has ceased air consumption and switches the compressor to stand-by mode. The main motor and fan motor will stop rotating to save energy.

In stand-by mode, if air consumption is resumed and pressure at the air outlet decreases to the loading set point, the controller will re-start the unit automatically.

Caution: The controller's display will indicate "STANDBY" whenever the compressor is in stand-by mode. In such a state, the compressor cabinet doors should not be opened and no maintenance work should be carried out due to the risk of injury if the unit re-starts automatically.

5.2.3 Shutdown

Normal Shutdown

If compressed air is no longer required, for example at lunchtime or end of the working day, pressing the Stop button  will initiate the compressor's normal shutdown sequence. The unit will either switch to or remain in unloading mode for 30 seconds to stabilise the internal air and oil systems before ceasing operation altogether. After a further 60 or 90 seconds depending on the model, the unit can only be re-started by pressing the Start button .

After shutdown, the air outlet valve should be closed to protect the unit against the influence of compressed air in the external pipeline network.

Fault Alarm Shutdown

If any electrical, pressure or temperature fault is detected, the controller will shut down the compressor immediately. If this happens, the fault should be investigated and rectified according to the indication on the controller's display panel. Press and hold the controller's Return / Reset button marked "C" for 5 seconds to reset the compressor after rectifying the fault or alternatively switch off the mains electricity supply for one minute.

Emergency Shutdown

If any abnormal condition arises during compressor operation, press the Emergency Stop button immediately for direct shut down of the unit to avoid any damage or injury. The fault should then be investigated and rectified before resetting the controller.

5.2.4 Monitoring During Operation

- a. Observe whether the compressor is emitting any abnormal noise or vibration. If present, an immediate shutdown should be performed.
- b. Do not loosen any pipes, bolts, threaded joints or electrical connections in the compressor when it's switched on or running. Any individual valves in the unit shouldn't be opened or closed at random.
- c. Observe the oil level. If the oil level is too low and not in the green zone on the oil level gauge, shut down the compressor and top-up the oil level.
- d. The operator on each shift should keep a written log recording the discharge pressure, discharge temperature, motor currents, oil level, run time, etc. and any maintenance or repair work carried out on the compressor.

5.2.5 Duty Cycle

The compressor is ideally suited for applications with a continuous compressed air demand in the vicinity of 100% of the unit's rated free air delivery.

During periods of very low air demand, the unit may not reach its normal operating temperature with sufficient frequency or duration. Sustained operation at very low duty cycle can result in a build-up of water condensate within the lubricating oil. If this occurs, the lubricating characteristics of the oil can be impaired and this may cause serious internal damage to the unit.

The compressor should be allowed ample running time in loading mode of at least 10 minutes per hour when in use to prevent such accumulation of condensate in the lubricating oil.

5.3 Long-Term Shutdown

5.3.1 Preparation

If the compressor is to be shut down for longer than one month, the following steps should first be performed:

- a. Any faults should be rectified in preparation for the unit's future use.
- b. The water condensate in the air-oil receiver should be completely drained out to prevent internal corrosion.
- c. All openings should be enclosed with plastic cloth or oiled paper to prevent the ingress of moisture and dust.

If the unit is to be out of service for more than two months, replace the lubricating oil beforehand and then run the compressor for 30 minutes. After three days, the water condensate in the air-oil receiver should be completely drained out.

5.3.2 Re-start

- a. Remove the protective plastic cloth or oiled paper.
- b. Measure the insulation resistance of motors to ground, which should be more than 1 M Ω .
- c. Follow the initial start-up procedure described in Section 5.1 to re-start the unit.

6.0 Maintenance

Before performing any maintenance work on the compressor, switch off the unit, isolate and tag-out the power supply, carefully release any residual air pressure from the internal air-oil receiver and any connected downstream piping in the user's network, and close the air outlet valve. And if possible, allow the unit to cool down if it's been running.

6.1 Lubricating Oil

The lubricating oil has a critical effect on the performance and service life of a rotary screw air compressor. If incorrect lubricating oil is used, it will cause severe damage to the compressor. Either of the following compressor lubricating oils is recommended:

Option 1: Compressor Oil – Mineral Based
Brand: Castrol
Product: AIRCOL PD46
Service Life: Up to 2,000 Hours

Option 2: Synthetic Compressor Oil - Polyalphaolefin Based
Brand: Castrol
Product: AIRCOL SR46
Service Life: Up to 8,000 Hours

Equivalent premium grade compressor oils from other suppliers may be substituted.

Caution: Use only one or the other of the above recommended oil types. Do not use a mixture of mineral and synthetic oils.

6.1.1 Oil Change Interval

- a. The initial oil change should be performed after the compressor operates for about 500 running hours or 3 months, whichever occurs first.
- b. If mineral-based lubricating oil is used, it should be replaced every 1,000 to 2,000 hours. If synthetic-based oil is used, it should be replaced every 4,000 to 8,000 hours. In either case, the lubricating oil should be replaced at least every 12 months if not sooner according to the running hours limit.
- c. If an oil sample analysis indicates that the lubricating oil needs to be changed, it should be done promptly.
- d. If the operating conditions are poor and the discharge temperature is often 95°C or higher, the oil change period should be halved.

6.1.2 Replacing Oil

- a. Press the Stop button  and then switch off, isolate and tag-out the power supply to the compressor.
- b. Close the air outlet valve.
- c. Wait at least two minutes for the pressure in the air-oil receiver to be completely released and monitor the pressure gauge to confirm. Slowly open the screw-plug at the oil filling port and then rotate the air end pulley by hand about 10 turns in the forward direction as marked on the air end.
- d. Remove the plug from the outlet of the oil drain ball valve and then open the valve to drain out the lubricating oil from the air-oil receiver. Collect the drained lubricating oil in a suitable container and properly dispose of it to prevent any environmental pollution.
- e. Close the oil drain ball valve and reinstall the oil drain plug. Fill the air-oil receiver with lubricating oil until the oil level reaches the upper limit of the green zone on the oil level gauge. Reinstall and tighten the screw-plug in the oil filling port.
- f. Re-start the compressor and allow it to operate in loading mode until the discharge temperature reaches at least 75°C and then shut down the unit. Wait five minutes and re-check the oil level. Top-up if necessary until the oil level is at the top-dead-centre mark on the gauge as shown in Figure 6-1.
- g. Reset the “LUBE” hours to zero via the user set parameters menu of the controller.



Figure 6-1 Full Oil Level Indication

6.2 Oil Filter

Initial replacement of the oil filter should be performed after the compressor operates for 500 hours or 3 months, whichever occurs first. Subsequent replacement is required every 1,000 hours or 12 months. If the lubricating oil needs to be replaced, the oil filter should be replaced at the same time. If the operating conditions are poor and the discharge temperature is

often 95°C or higher, the oil filter replacement period should be halved.

The replacement steps are as follows:

- a. Press the Stop button  and then switch off, isolate and tag-out the power supply to the compressor.
- b. Close the air outlet valve.
- c. Wait at least two minutes for the pressure in the air-oil receiver to be completely released and monitor the pressure gauge to confirm.
- d. Use an oil filter wrench to remove the oil filter by unscrewing it anticlockwise.
- e. Clean the sealing washer of the new oil filter and then apply a thin layer of clean lubricating oil onto it.
- f. Install the new oil filter by screwing it on clockwise until the sealing washer contacts the oil filter base and then tighten it by hand a further $\frac{1}{2}$ to $\frac{3}{4}$ of a turn.
- g. Reset the “OIL FILTER” hours to zero via the user set parameters menu of the controller.

6.3 Air-Oil Separator

The air-oil separator should be replaced after every 2,000 hours or 1 year, whichever occurs first. In a dirty or dusty environment, the replacement period should be halved. It is not possible to clean the air-oil separator element, only replacement is allowed.

The procedure for replacing the air-oil separator is essentially the same as that described above for replacing the oil filter.

Caution: When removing the air-oil separator, the separator connector may become partly or wholly unscrewed from its base. Use a spanner to check and tighten the separator connector if necessary, taking care not to damage its sealing O-rings.

Caution: When replacing the air-oil separator, it is essential to prevent ingress of foreign matter into the air-oil receiver.

After replacing the air-oil separator, reset the “O-A FILTER” hours to zero via the user set parameters menu of the controller.

6.4 Air Pre-Filters

The air pre-filters are accessed by removing the compressor’s side panels. Refer to Figure 6-2.

Wash the foam elements in warm, soapy water and then rinse clean. Do not use any solvents or chemical cleaners.

Shake the foam elements to remove excess water and then blow dry using compressed air or allow to dry naturally before re-installation. Do not operate the unit with the air pre-filters or side panels removed.



Figure 6-2 Air Pre-Filters Location and Removal

6.5 Air Filter

- a. After removal from the air filter assembly and working at a distance of at least 5 m from the compressor, the air filter element can be blown clean from the inside to the outside using compressed air at a pressure no higher than 210 kPa. Refer to Figure 6-3. Keep the air blowing outlet more than 20 mm away from the inner surface of the filter element. After the air filter element is cleaned 3 to 4 times, it should be replaced.



Figure 6-3 Air Filter Element Cleaning

- b. Do not hit the air filter element to shake free any dust nor clean it with water or any other liquid. If the filter element is damaged, it should be replaced. If the filter element is oily or contaminated severely, no cleaning is practicable and the element should be replaced.
- c. The maximum service life of the air filter element is 2,000 hours. If the operating conditions of the compressor are adverse (i.e. dusty or dirty), then the replacement period should be halved.
- d. After replacing the air filter element, reset the “AIR FILTER” hours to zero via the user set

parameters menu of the controller.

6.6 Oil Cooler and Air After-Cooler

If the air discharge temperature from the compressor is excessively high, the combined oil cooler and air after-cooler mounted at the top of the compressor cabinet should be blown off with clean compressed air to remove any dirt or dust. If it can't be cleaned in this manner, then wash it with a proper cleaning agent. Never use a metal wire brush or metal scraper to remove the dirt or dust. The finned cooler should be kept clean and free of any obstructions at all times.

The underside of the finned cooler can be accessed for cleaning or inspection via removable panels on two sides of the cooling fan plenum.

6.7 Safety Valve

Check the safety valve on the air-oil receiver regularly to verify that it's operating freely. While the receiver is pressurised to at least 650 kPa (94 psi), pull the ring on the safety valve and allow it to snap back to its normal position. If air leaks out after the ring has been released, or the valve is stuck and cannot be actuated by pulling the ring, the safety valve is faulty and must be replaced before operating the compressor.

Caution: Take care when testing the safety valve as compressed air will discharge from the valve with high velocity.

Caution: Do not tamper with the safety valve. It is designed to automatically release air if the receiver pressure exceeds the safety valve's pressure setting.

6.8 V-Belts

- a. Check the condition and tension of the V-belts after the compressor operates for about 500 running hours or 3 months, whichever occurs first, and thereafter each 1,000 running hours or 1 year. If correctly tensioned, a force of 40 N (4 kg) applied mid-span on a single V-belt should cause it to deflect about 8 mm ($\approx 5/16$ inch).
- b. It is essential to use replacement V-belts with the correct specifications. Replace all V-belts simultaneously and do not mix belts from different manufacturers. Also, do not mix new and used V-belts.
- c. To adjust the V-belt tension, the four fixing bolts under the main motor should be slightly loosened at first, and then the adjustment screw can be turned to move the main motor to tension the V-belts. After adjustment, the fixing bolts holding down the main motor should be retightened. Refer to Figure 6-4.
- d. When carrying out maintenance on the compressor, do not allow any oil or other liquids to splash onto the V-belts or pulleys to prevent belt slippage.

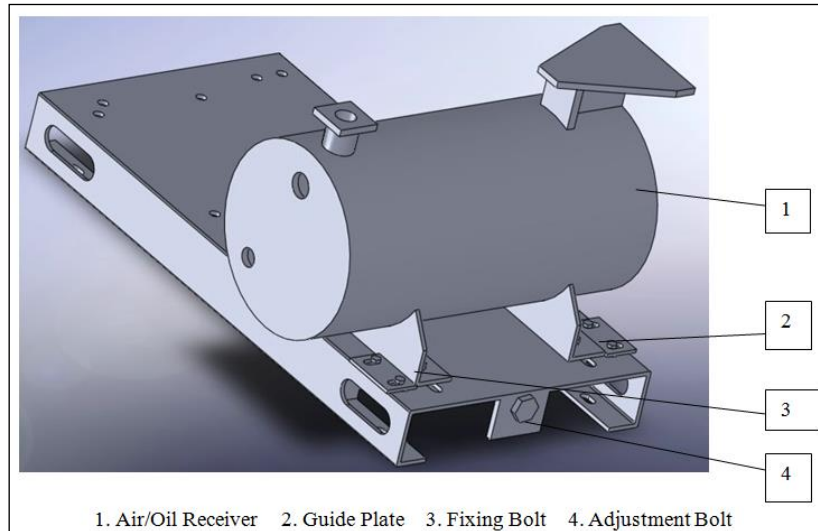

Figure 6-4 V-Belt Tension Adjustment

6.9 Motor Bearings

The main motor's drive end (DE) and non-drive end (NDE) bearings should be re-greased at least every 2,000 hours or 1 year, whichever occurs first. Mobil Polyrex EM grease or equivalent is recommended. Do not mix different types of grease. This maintenance task is best undertaken when the motor is still warm to allow for better dispersion of the grease.

- a. Locate the grease nipple on top of each DE and NDE bearing and also the grease drain plug underneath (that may be offset to one side). Refer to Figure 6-5. It is often necessary to temporarily remove the motor fan cowl on the non-drive end to access these points.
- b. Remove the drain plug and clean old grease from the drain opening.
- c. Clean the grease nipple and grease gun nozzle to prevent contaminants entering into the bearing.
- d. Using a hand operated grease gun, pump the requisite quantity of grease in through the nipple as specified on the motor bearing data nameplate.
- e. Operate the compressor for 10 to 30 minutes with the drain plug removed to allow any excess grease to vent out through the drain.
- f. Shut down the compressor and make it safe to work on again. Then clean up any expelled grease from the drain outlet and re-install the plug.

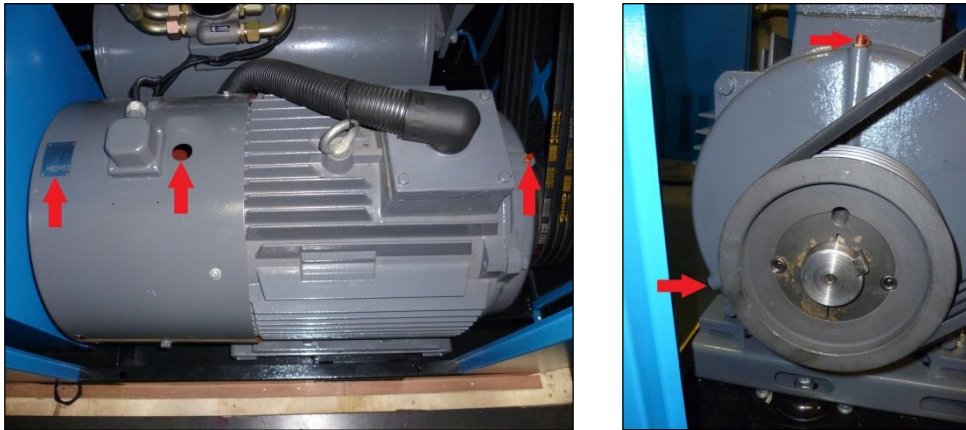

Figure 6-5 Motor Bearing Re-Greasing

6.10 Electrical Cabinet

The compressor's electrical cabinet and the components housed therein should be checked and cleaned by a licensed electrician every 2,000 hours or 1 year, whichever occurs first. The external and internal surfaces of the electrical cabinet should be vacuum cleaned and wiped down with a dry cloth. The electrical components and wiring within the cabinet should be vacuum cleaned only with particular attention given to the cabinet's louvre vents.

6.11 Preventative Maintenance Program

Maintenance Task	Maintenance Interval *						
	8 h	40 h	500 h	1,000 h	2,000 h	4,000 h	8,000 h
	Daily	Weekly	Qtrly	1 Year			2 Years

Routine Operation							
Check / Top-Up Oil Level	•						
Drain Air-Oil Receiver Condensate	•						
Check Controller and Gauge Readings	•						
Air System							
Clean Air Pre-Filters			•				
Clean Air Filter Element			•				
Clean Oil Cooler and Air After-Cooler			•				
Check Safety Valve				•			
Replace Air Filter Element					•		
Replace Inlet Valve Maintenance Kit							•
Replace Minimum Pressure Valve Maintenance Kit							•
Air-Oil Receiver Ext. Inspection							•
Oil System							
Replace Oil Filter			• Initial	•			
Replace Oil			• Initial		• ¹		• ²
Replace Air-Oil Separator					•		
Replace Thermostatic Valve Maintenance Kit							•
Drive System							
Check / Adjust V-Belt Tension			• Initial	•			
Replace V-Belts							•
Re-Grease Motor Bearings					•		
Electrical System							
Check Emergency Stop Button			•				
Check Electrical Connections					•		
Clean Electrical Cabinet					•		
Check Motor Insulation (> 1 MΩ)						•	

* Compressor running hours or elapsed time period, whichever occurs first. In adverse working conditions, such as dusty environment and / or high temperature, the maintenance intervals should be halved.

¹ Using mineral-based compressor lubricating oil; 2,000 hours maximum or 1 year.

² Using synthetic-based compressor lubricating oil; 8,000 hours maximum or 1 year.

6.12 Dismantling and Disposal

There is no requirement for the compressor to be dismantled during normal operation other than for major repair / overhaul or prior to final disposal at the end of its service life.

Dismantling should only be carried out by a mechanically proficient person with access to proper tools or alternatively by an authorised Senator dealer for a fee.

The air-oil receiver and air receiver tanks should be rendered unusable for pressure service prior to disposal, for example by cutting or massive deformation. This is to prevent their unauthorised and unsafe use by others.

Do not pollute the environment by improper or illegal disposal of the waste oil or condensate.

Similarly, do not pollute the environment by improper or illegal disposal of the compressor either as a whole or dismantled. Take the unwanted unit or components to your local recycling centre instead. The compressor is almost entirely made of metal that can usually be sold to scrap metal recyclers.

7.0 Fault Diagnosis and Repair

7.1 Compressor Fault Analysis

Please refer to this section for assistance with fault diagnosis and repair in the unlikely event that any problem might occur with your air compressor.

It is important to collect operating data about the unit routinely and systematically. Based on this data, the operator can more readily detect any changes in the unit's performance and possibly identify any actual or potential faults.

Before repairing or replacing any components, the various factors that may cause a particular fault should be investigated in detail to identify the exact reason if possible. Don't disassemble or move the compressor unit in a disorderly way, otherwise unnecessary damage may be caused.

Routine observations should be logged of the following inspections:

- a. Whether any wiring connections/terminals are loose or disconnected.
- b. Whether any piping is damaged.
- c. Whether any components are damaged due to over-heating or short circuiting. An obvious tell-tale sign is discoloration or a burning odour.
- d. Whether any air or oil leakage is evident.
- e. Whether any abnormal noise is audible.
- f. Whether any abnormal vibration is detectable.
- g. Whether any messages / readings shown on the controller display or other gauges deviate from their regular values.

7.2 Troubleshooting Chart

Symptom	Possible Cause	Corrective Action
Compressor fails to start-up.	<ol style="list-style-type: none"> 1. Mains electricity supply is not switched on or functioning. 2. Electricity supply voltage is too low. 3. Electricity supply is not functioning on all three phases. 4. Loose wiring or poor contact. 5. Motor failure. 6. Air end failure. 	<ol style="list-style-type: none"> 1. Check mains electricity supply is switched on and live at the compressor's incoming terminals. 2. Investigate and rectify electricity supply voltage. 3. Investigate and rectify electricity supply on all three phases. 4. Check and tighten all electrical connections. 5. Repair or replace motor. 6. Repair or replace air end.
Air discharge temperature is too high ($\geq 105^{\circ}\text{C}$).	<ol style="list-style-type: none"> 1. Insufficient lubricating oil. 2. Too high ambient temperature. 3. Oil cooler fins are blocked. 4. Oil filter is blocked. 5. Thermostatic valve is faulty. 6. Incorrect grade of lubricating oil. 7. Cooling fan is faulty. 8. Temperature sensor is faulty. 	<ol style="list-style-type: none"> 1. Check oil level in air-oil receiver. 2. Improve ventilation conditions and reduce room temperature. 3. Clean oil cooler fins. 4. Replace oil filter. 5. Check whether oil is cooling down via oil cooler. If not, repair or replace thermostatic valve. 6. Change to correct grade of lubricating oil. 7. Repair or replace cooling fan and fan motor. 8. Check or replace temperature sensor.
Air discharge temperature is too low ($\leq 80^{\circ}\text{C}$).	<ol style="list-style-type: none"> 1. Very low ambient temperature. 2. Thermostatic valve is faulty. 3. Temperature sensor is faulty. 	<ol style="list-style-type: none"> 1. Change ventilation conditions and increase room temperature. 2. Repair or replace thermostatic valve. 3. Check or replace temperature sensor.
Air supply pressure (to user's air piping network) is too low.	<ol style="list-style-type: none"> 1. Pressure settings are too low. 2. Air consumption is greater than compressor output. 3. Air filter is blocked. 4. Inlet valve isn't opening fully. 5. Pressure sensor is faulty. 6. Minimum pressure valve is faulty. 7. Air-oil separator is blocked. 	<ol style="list-style-type: none"> 1. Check the controller's pressure settings. 2. Reduce air consumption and / or check air piping system for leakage. 3. Clean or replace air filter element. 4. Check the action of inlet valve. 5. Check or replace pressure sensor. 6. Repair or replace minimum pressure valve. 7. Check or replace air-oil separator.
Air supply pressure (to user's air piping network) is too high.	<ol style="list-style-type: none"> 1. Pressure settings are too high. 2. Air system unloading components are faulty, e.g. solenoid valve, inlet valve and vent valve. 3. Leakage in control air piping. 4. Pressure sensor is faulty. 	<ol style="list-style-type: none"> 1. Check the controller's pressure settings. 2. Check, repair or replace unloading components. 3. Check and rectify leakage. 4. Check or replace pressure sensor.

Symptom	Possible Cause	Corrective Action
Air discharge pressure (to the air-oil receiver) is too high.	<ol style="list-style-type: none"> 1. Pressure settings are too high. 2. Air system unloading components are faulty, e.g. solenoid valve, inlet valve and vent valve. 3. Leakage in control air piping. 4. Air-oil separator is blocked. 5. Minimum pressure valve is faulty. 6. Pressure sensor is faulty. 	<ol style="list-style-type: none"> 1. Check the controller's pressure settings. 2. Check, repair or replace unloading components. 3. Check and rectify leakage. 4. Check or replace air-oil separator. 5. Repair or replace minimum pressure valve. 6. Check or replace pressure sensor.
Compressed air has relatively high oil content and oil refilling period is shortened.	<ol style="list-style-type: none"> 1. Oil level in the air-oil receiver is too high. 2. Filter or orifice in the oil return pipe or the pipe itself is blocked. 3. Air-oil separator element or O-ring is damaged. 4. Leakage in oil piping. 5. Oil is wrong grade causing excessive foaming. 	<ol style="list-style-type: none"> 1. Check oil level and drain out any excess. 2. Clean or replace filter element, orifice and pipe. 3. Check or replace air-oil separator element, O-ring and tightness of connector. 4. Check and rectify leakage. 5. Replace oil with correct grade.
Oil mist leaks out of air filter during shutdown.	<ol style="list-style-type: none"> 1. Nil or insufficient operation in unloading mode before shut down. 2. Solenoid valve, inlet valve or vent valve is faulty. 3. Venting of air-oil receiver is incomplete. 4. Minimum pressure valve is faulty. 	<ol style="list-style-type: none"> 1. Check and follow correct procedure for normal shut down. Check the controller's time settings 2. Check or replace solenoid valve, inlet valve or vent valve. 3. Check vent valve. 4. Repair or replace minimum pressure valve.
Switching between unloading and loading modes is too frequent.	<ol style="list-style-type: none"> 1. Air piping leakage. 2. The differential between the unload and load pressure settings is too small. 3. Air consumption and system air pressure fluctuate excessively. 	<ol style="list-style-type: none"> 1. Check and rectify air leakage. 2. Check the controller's pressure settings. 3. Increase air storage capacity in the user's piping network.

8.0 Warranty

8.1 Proof of Purchase

Please complete the following details about your air compressor for future reference regarding warranty, spare parts and service.

Date Purchase:

Purchased From:

Tax Invoice Number:

Air Compressor Model Number:

Air Compressor Serial Number:

It is recommended that you keep a copy of the original tax invoice with this manual.

8.2 Warrantor

Name: Glenco Air & Power Pty Ltd
(ABN 21101370085)

Address: 19 Corymbia Place, Parkinson, QLD, 4115, Australia

Phone: (07) 3386 9999

Email: sales@glencomfg.com.au

Web: www.glencoairpower.com.au

8.3 Warranty Conditions

Glenco Air & Power Pty Ltd (the “Company”) warrants that the Goods shall be free from defects in material and workmanship for a period of twelve (12) months from the date of original sale (hereinafter the “Warranty Period”).

The Warranty Period is continuous from the date of original sale and does not re-start upon the repair or replacement of the Goods or any part thereof.

Upon return – transportation charges prepaid by the Consumer – to the Company’s or its nominated dealer’s premises within the Warranty Period, the Company shall repair or replace, at its option, any Goods which it determines to contain defective material or workmanship, and shall return said Goods to the Consumer free-on-board (FOB) at the Company’s or agent’s premises. The repair or replacement work will be scheduled and performed according to the Company’s normal work flow and availability of replacement parts.

The Company shall not be obligated, however, to repair or replace Goods which have been: repaired by others; abused; improperly installed, operated, maintained, repaired, transported or stored; not serviced to schedule using genuine spare parts; altered or otherwise misused or damaged in any way.

The Company shall not be responsible for any diagnosis, communication, dismantling, packing, handling, freight, and reassembly or reinstallation charges.

Freight damage, pre-delivery service, normal operating adjustments, preventative maintenance service, consumable items, cosmetic damage, corrosion, erosion, normal wear and tear, performance, merchantability, and fitness for a particular purpose are not covered under this Warranty. Consumable items include lubricants, filters and V-belts.

The Company shall not be liable for any repairs, replacements, or adjustments to the Goods or any costs of labour performed by the Consumer or others without the Company's prior written approval.

To the extent permissible by law and notwithstanding any other clause in these Warranty Conditions, the Company excludes all liability whatsoever to the Consumer arising out of or in any way connected with a contract for any consequential or indirect losses of any kind howsoever arising and whether caused by breach of statute, breach of contract, negligence or other tort.

The Company's liability will be limited to, in the case of products, the replacement of the products, the supply of equivalent products or the payment of the cost of replacing the products or of acquiring equivalent products or, in the case of services, the supply of the services again or the payment of the cost of having the services supplied again. The choice of remedy will be at the discretion of the Company and the Consumer acknowledges that this limitation of liability is fair and reasonable.

This Warranty is available only to the original Consumer bearing the original tax invoice from the Company or one of its authorised dealers as proof of purchase. Goods purchased from any other party such as a private seller, auction house, eBay seller, etc. are not covered by this Warranty.

Our goods come with guarantees that cannot be excluded under the Australian Consumer Law. You are entitled to a replacement or refund for a major failure and compensation for any other reasonably foreseeable loss or damage. You are also entitled to have the goods repaired or replaced if the goods fail to be of acceptable quality and the failure does not amount to a major failure.

Appendix A MAM-870 Controller

A1.0 Basic Operation

A1.1 Description of Keypad

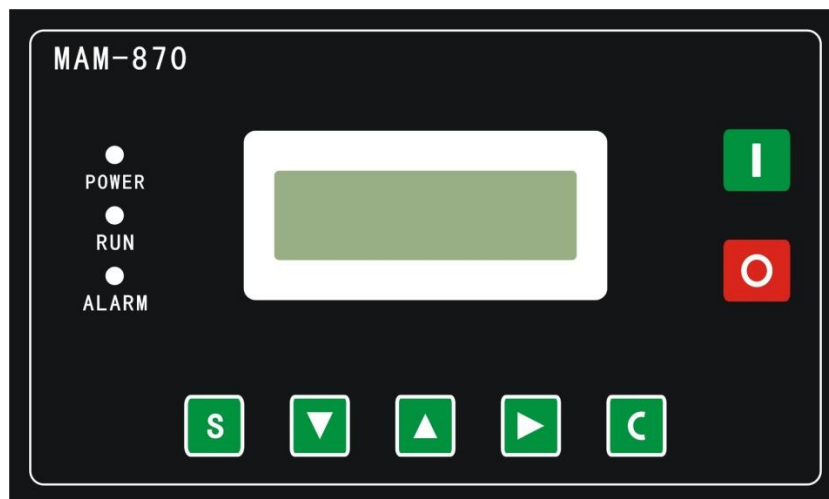

I - **Start Button.** Press this button to start the compressor. The unit will start running immediately unless it's in a delay countdown after an earlier manual or automatic shutdown as shown on the controller's display.

O - **Stop Button.** Press this button to stop the compressor for a normal shutdown. If running, the unit will immediately switch to unloading mode and initiate a delay countdown as shown on the controller's display before switching off entirely. If stopped after an earlier automatic shutdown, pressing the Stop button will disable the automatic re-start function until the Start button is pressed again.

S - **Set Button.** Press this button to confirm the data input and save it after modification. When the compressor is running in automatic mode, pressing this button will switch the unit to manual load / unload operation; this feature should not be used in normal conditions.

▼ - **Down Button.** Press this button to move downward during data modification. Press this button to select the next menu during menu selection.

▲ - **Up Button.** Press this button to move upward during data modification. Press this button to select the next menu during menu selection.

▶ - **Cursor / Confirm Button.** This button can be used as a cursor during data modification and as a confirmation during menu selection.

C - **Return / Reset Button.** Press this button to return to an upper menu during menu selection.

Press and hold this button for 5 seconds to reset the compressor when the unit is stopped after alarm shutdown.

POWER Indicator. The red light is illuminated continuously whenever the compressor’s electrical power supply is switched on.

RUN Indicator. The green light is illuminated continuously whenever the compressor is running.

ALARM Indicator: The red light flashes accompanied by a continuous audible beep whenever the controller detects a warning or pre-alarm condition, e.g. oil filter overdue for replacement. The red light is illuminated continuously accompanied by a continuous audible beep whenever the controller detects an alarm condition and prevents the compressor from starting or shuts it down if already running, e.g. electrical supply phase reversal, high temperature, etc.

A1.2 Status Display and Operation

The display interface appears as follows when the compressor is first switched on:

SCREW COMPRESSOR

The status display will change after 5 seconds to the following standard layout:

PRES: 0.00MPa SYS STOP

Press the ► button to display the following:

TEMP: 20°C SYS STOP

During normal compressor operation, pressing the ► button will cycle the top line of the display between the outlet air pressure and the air end discharge temperature readings as shown above.

A “◇” symbol will blink on the right-hand end of the display’s top line whenever the compressor is operating under interconnected sequencing control.

Concurrently during normal compressor operation, the bottom line of the display will indicate the status of the unit as described in the following table.

Status Display	Status Description
SYS STOP	The compressor has not operated since its power supply was last switched on.
Y START *S	The first brief phase of compressor startup after manual or automatic activation that will be completed in * seconds.
Δ RUN *S	The second brief phase of compressor startup after manual or automatic activation that will be completed in * seconds.
AUTO LOAD	The compressor is running automatically in loading mode.
AUTO U.L.	The compressor is running automatically in unloading mode after having reached the unload pressure setting.
STANDBY **S	The compressor has been running for an extended period of time in unloading mode and has now shut down automatically. After ** seconds, the unit will enter the standby mode. The unit will then automatically re-start if the tank air pressure drops to or below the load pressure setting.
STOPPING **S	The Stop button has been pressed and the compressor will automatically shut down in ** seconds.
SYS STOP **S	The compressor has been shut down by pressing the Stop button and will not re-start automatically. After ** seconds, the unit can only be re-started manually by pressing the Start button.
C**	Whenever the compressor is configured for interconnected sequencing control, its COM ADDRESS is displayed in the range from C01 to C16. The compressor designated C01 is the master unit and the others in the group are slaves.

Note: In the above table, the symbol “*” represents a whole number between 0 and 9.

A1.3 Run Parameter Review

During normal compressor operation, press the ▼ button to display the Menu Selection Interface:



With the black cursor on the RUN PARAMETER selection, press the ► button to display the first run parameter screen:

MOTOR(A) A-	0.0
B-	0.0 C- 0.0

Then press the ▼ button repeatedly to scroll through the full list of run parameters and their status as described in the table below.

Run Parameter Display	Run Parameter Description
MOTOR (A)	Main motor current in each of the three phases.
FAN (A)	Fan motor current in each of the three phases.
TOTAL RUN TIME	The total accumulated running time of the compressor.
TOTAL LOAD TIME	The total time that the compressor has been running in loading mode.
LOAD NUMBER	The total number of times that the compressor has run in loading mode.
THIS RUN TIME	The total time that the compressor has been running since last being manually started by pushing the Start button.
THIS LOAD TIME	The total time that the compressor has been running in loading mode since last being manually started by pushing the Start button.
OIL FILTER TIME	The total time that the compressor has been running since its last oil filter replacement.
O-A FILTER TIME	The total time that the compressor has been running since its last air-oil separator replacement.
AIR FILTER TIME	The total time that the compressor has been running since its last air filter replacement.
LUBE TIME	The total time that the compressor has been running since its last oil change.
GREASE TIME	The total time that the compressor has been running since its motor bearings have been re-greased.
BELT TIME	The total time that the compressor has been running since its V-belts have been replaced.

Run Parameter Display	Run Parameter Description
ALARM 1	A record of the most recent alarm condition and the running hours at which it occurred.
ALARM 2	A record of the second most recent alarm condition and the running hours at which it occurred.
ALARM 3	A record of the third most recent alarm condition and the running hours at which it occurred.
ALARM 4	A record of the fourth most recent alarm condition and the running hours at which it occurred.
ALARM 5	A record of the fifth most recent alarm condition and the running hours at which it occurred.
PRODUCT DATE	The compressor's date of manufacture.
SERIAL NUMBER	The compressor's serial number.
C-STATE	Indicates whether the compressor is receiving or transmitting sequencing commands.

A2.0 User and Factory Set Parameters

A2.1 Parameter View and Modification

The user set parameters and factory set parameters cannot be modified during compressor operation. They should only be modified, if required, after the compressor has been manually stopped by pressing the Stop button.

Press the ▼ button once in the Menu Selection Interface to select "USE PARAMETER" for access to the user set parameters.



Press the ▼ button once more to select "FAC PARAMETER" for access to the factory set parameters.



Press the ▼ button once more to select "MOD PARAMETER" for access to the calibration set parameters.



When the black cursor is on "USE PARAMETER", press the ► button and the following interface will appear:



Now press the ► button to bring up the following interface where the USER PASSWORD is required:



The USER PASSWORD is 9999. Enter it using the ► button to move the blinking cursor from left to right, and use the ▼ or ▲ buttons to change the numerical value. Then press the S button and the previous screen will now reappear with the additional symbol “*” indicating that the password has been entered and the parameters can now be modified, for example:



Use the ▼ or ▲ buttons to scroll through the entire list of user set parameters. To modify any value, press the ► button and the blinking cursor will appear. Press the ► button again to move the blinking cursor from left to right, and use the ▼ or ▲ buttons to change the numerical value. Press the S button to confirm the change and the blinking cursor will disappear, or press the C button to cancel the change.

Upon completion of review and / or changes to the user set parameters, press the C button to return to the previous menu.

A2.2 User Set Parameters

The user set parameters have been pre-programmed in accordance with the following table and should NOT be changed without reference to the manufacturer.

Parameter	Set Value	Function
LOAD PRES	00.70 MPa or 00.90 MPa ^	The compressor will commence loading operation at or below this pressure. Use the lower value for standard 8 bar maximum pressure configuration. Use the higher value for optional 10 bar ^ maximum pressure configuration.
UNLOAD PRES	00.80 MPa or 01.00 MPa ^	The compressor will commence unloading operation at or above this pressure. Use the lower value for standard 8 bar maximum pressure configuration. Use the higher value for optional 10 bar ^ maximum pressure configuration.
FAN START TEMP	0080 °C	The cooling fan will start at or above this air end discharge temperature.
FAN STOP TEMP	0070 °C	The cooling fan will stop at or below this air end discharge temperature.

Parameter	Set Value	Function
MOTOR DELAY T	0015 S	When using the controller to protect the main motor against overload, the time value specified here must be longer than the STAR DELAY TIME plus LOAD DELAY TIME. This is to ensure that a false overload alarm does not occur due to motor in-rush current at startup.
FAN DELAY TIME	0015 S	When using the controller to protect the fan motor against overload, the time value specified here must be long enough to avoid the motor in-rush current at startup.
STAR DELAY TIME	0010 S	The main motor starting time in star connection.
LOAD DELAY TIME	0003 S	The loading delay time after the main motor switches from star to delta connection.
EMPTY DELAY T	0300 S	Maximum continuous time in unloading mode. The compressor will automatically stop after this time and enter the standby mode.
STOP DELAY TIME	0030 S	After pressing the Stop button, the compressor will not stop running until this time has elapsed in the unloading mode.
START DELAY T	0060 S [LS18-45] 0090 S [LS55-75]	The compressor cannot be re-started before this time has elapsed after being either manually or automatically shut down.
START MODE	LOCAL or FAR	Use “LOCAL” for standalone operation via the controller’s push buttons or use “FAR” to enable the remote start / stop and sequential control features.
LOAD MODE	AUTO	Use only the specified set value. When the manual mode is set, the Load/Unload function can only be executed manually.
COM MODE	PROHIBIT or SEQUENCE	Use “PROHIBIT” for standalone operation or “SEQUENCE” for interconnected sequential control.
COM ADDRESS	0001 or 0002 ~ 0016	0001: Standalone compressor or master compressor in an interconnected group. 0002 ~ 0016: Slave compressor in an interconnected group. Note that each slave unit must be assigned a unique COM ADDRESS in ascending numerical order.
SEQ STATE	MASTER or SLAVE	Use “MASTER” for standalone compressor or master compressor in an interconnected group. Use “SLAVE” for each dependent compressor in an interconnected group.
TOGGLES TIME	0000 H or 0010 H	Set to “0000” for standalone compressor or “0010” for interconnected compressor to define the run-time polling interval.

PARAMETER	SET VALUE	FUNCTION
SEQ NUMBER	0001 or 0002 ~ 0016	Set to “0001” for standalone compressor or between “0002” and “0016” to specify the total number of interconnected compressors.
SEQ LOAD PRES	00.72 MPa or 00.92 MPa ^	The lead compressor in an interconnected group will commence loading operation at or below this pressure. Use the lower value for standard 8 bar maximum pressure configuration. Use the higher value for optional 10 bar ^ maximum pressure configuration.
SEQ U.L. PRES	00.78 MPa or 00.98 MPa ^	The lag compressor will commence unloading operation at or above this pressure. Use the lower value for standard 8 bar maximum pressure configuration. Use the higher value for optional 10 bar ^ maximum pressure configuration.
SEQ DELAY TIME	0030 S	The time delay between successive commands from the master controller to compressors in an interconnected group.
OIL FILTER RST	0000 H	Reset to zero hours ONLY when the oil filter is replaced.
O-A FILTER RST	0000 H	Reset to zero hours ONLY when the air-oil separator is replaced.
AIR FILTER RST	0000 H	Reset to zero hours ONLY when the air filter is replaced.
LUBE RESET	0000 H	Reset to zero hours ONLY when the lubricating oil is changed.
GREASE RESET	0000 H	Reset to zero hours ONLY when the motor is re-greased.
BELT RESET	0000 H	Reset to zero hours ONLY when the V-belts are replaced.
OIL FILTER SET	1000 H	Oil filter replacement interval.
O-A FILTER SET	2000 H	Air-oil separator replacement interval.
AIR FILTER SET	2000 H	Air filter replacement interval.
LUBE SET	2000 H	Lubricating oil change interval.
GREASE SET	2000 H	Motor re-grease interval.
BELT SET	8000 H	V-belt replacement interval.
LANGUAGE SEL.	ENGLISH	Set this value to the required display language.
USER PASSWORD	9999	For access to the User Set Parameters.

^ DO NOT enter the 10 bar maximum pressure parameters without also changing the compressor’s air end speed by replacing certain V-belt drive components otherwise the unit will be damaged. Refer to the manufacturer for instructions.

A2.3 Factory Set Parameters

The factory set parameters can only be accessed for review and / or change by using the FACTORY SET PASSWORD, which is made available to service technicians upon request. It is unlikely that any of the factory set parameters would need to be changed during the life of the air compressor set after dispatch from the manufacturer.

The factory set parameters have been pre-programmed in accordance with the table shown below.

Note that certain parameters prefixed “#” can only be accessed with the SUPER PASSWORD, which is only available for use by the manufacturer.

Parameter	Set Value	Function
MOTOR CURR	038.6 A [LS18] 045.7 A [LS22] 061.8 A [LS30] 075.0 A [LS37] 090.7 A [LS45] 110.5 A [LS55] 147.6 A [LS75]	After the starting delay time, when the main motor current is greater than 1.2 times the set value and less than 4 times the set value, the compressor will shut down per the overload alarm feature. Use the specified value according to the compressor model.
FAN CURR	001.0 A [LS18] 001.0 A [LS22] 001.6 A [LS30] 001.6 A [LS37] 001.6 A [LS45] 002.2 A [LS55] 003.2 A [LS75]	After the starting delay time, when the fan motor current is greater than 1.2 times the set value and less than 4 times the set value, the compressor will shut down per the overload alarm feature. Use the specified value according to the compressor model.
PRE-ALARM TEMP	0105 °C	A pre-alarm warning will be activated if the air end discharge temperature reaches this set value.
STOP TEMP	0110 °C	A shutdown alarm will be activated if the air end discharge temperature reaches this set value.
STOP PRESS	00.85 MPa or 01.05 MPa ^	A shutdown alarm will be activated if the discharge air pressure reaches this set value. Use the higher value for optional 10 bar maximum pressure configuration. ^
MAX U.L. PRESS	00.80 MPa or 01.00 MPa ^	The UNLOAD PRES set by the user cannot exceed this value. Use the higher value for optional 10 bar maximum pressure configuration. ^
#TOTAL RUN TIME	***** H	The total running time history can only be altered by the manufacturer. Do not change it.
TOTAL LOAD TIME	***** H	The total loading time history should only be altered by the manufacturer. Do not change it.
RESET FAULT	8888	Enter the set value to clear the compressor's fault history.
CURR UNBALANCE	0010	When the Maximum Phase Current ÷ Minimum Phase Current is greater than 1 + (Set Value ÷ 100), the current unbalance alarm will shut down the compressor. Set this value greater than 15 to disable the current unbalance shutdown alarm function.
LACK PHASE TIME	005.0 S	The delay time before shutdown alarm due to an electrical supply phase failure. Set this value to ≥ 20 S to disable the lack-of-phase shutdown alarm function.

Parameter	Set Value	Function
PRODUCT DATE	****Y**M**D	The manufacturer inputs the production date of the compressor. Do not change it.
SERIAL NUMBER	*****	The manufacturer inputs the serial number of the compressor. Do not change it.
#PHASE PROTECT	ENABLE	Enables or disables the electrical phase sequence (rotation) shutdown alarm. It must always be enabled to protect against counter-rotation of the air end. Do not change it.
#SELECT FREQ	50 Hz	Sets the frequency of the electricity supply. Do not change it.
SEQ MODE	COMPATIBLE	Sets the sequencing function compatibility with other controllers from the same manufacturer.
HIGH VOLTAGE	0440 V	Use only the specified set value. Note: The high voltage shutdown function is not available on this model.
LOWER VOLTAGE	0356 V	Use only the specified set value. Note: The low voltage shutdown function is not available on this model.
LOW T PROTECT	0000 °C	If the air end temperature is lower than the set value, the compressor cannot be started and a low temperature alarm will be activated.
#MAX RUN TIME	0000 H	A shutdown alarm will be activated if the total accumulated run time exceeds this value. Set it to “0000” to disable the maximum run time shutdown alarm function.
ALARM LONG STOP	0000 H	A shutdown alarm will be activated if a pre-alarm maintenance warning is not reset within this number of running hours. Set the value to “0000” to disable the overdue maintenance shutdown alarm function.
COM SET PAR.	ENABLE	Spare parameter setting channel.
PARAMETER 1	****	Sets the FACTORY SET PASSWORD. Do not change it.
TOTAL LOAD NUM	****	The total number of loading cycles history should only be altered by the manufacturer. Do not change it.

Note: In the above table, the symbol “*” represents a whole number between 0 and 9.

^ DO NOT enter the 10 bar maximum pressure parameters without also changing the compressor’s air end speed by replacing certain V-belt drive components otherwise the unit will be damaged. Refer to the manufacturer for instructions.

A2.4 Calibration Set Parameters (MOD PARAMETER)

The calibration set parameters can only be accessed for review and / or change by using the CALIBRATION SET PASSWORD, which is made available to service technicians upon request. It is unlikely that any of the calibration set parameters would need to be changed during the life of the air compressor set after dispatch from the manufacturer.

The calibration set parameters have been pre-programmed in accordance with the table shown below.

Parameter		Set Value	Function
MOTOR A	TARGET	***.* A	Enter the true current value (measured with an accurate external ammeter) in the main motor supply Phase A while the compressor is running in a steady state condition. The controller will divide the true current value by the indicated current value (as measured internally by the compressor) to work out the calibration coefficient. The true current value is entered here for one-time calculation only and will not be saved.
	COEF.	*.***	The controller displays the corrected current value for main motor supply Phase A, which equals the indicated current value times the calibration coefficient.
MOTOR B	TARGET	***.* A	[As described above.]
	COEF.	*.***	[As described above.]
MOTOR C	TARGET	***.* A	[As described above.]
	COEF.	*.***	[As described above.]

Parameter		Set Value	Function
FAN A	TARGET	***.* A	Enter the true current value (measured with an accurate external ammeter) in the fan motor supply Phase A while the compressor is running in a steady state condition. The controller will divide the true current value by the indicated current value (as measured internally by the compressor) to work out the calibration coefficient. The true current value is entered here for one-time calculation only and will not be saved.
	COEF.	*.***	The controller displays the corrected current value for fan motor supply Phase A, which equals the indicated current value times the calibration coefficient.
FAN B	TARGET	***.* A	[As described above.]
	COEF.	*.***	[As described above.]
FAN C	TARGET	***.* A	[As described above.]
	COEF.	*.***	[As described above.]

Note: In the above table, the symbol “*” represents a whole number between 0 and 9.

A3.0 Alarms and Messages

A3.1 Pre-Alarm Warnings

The controller will intermittently display a self-explanatory pre-alarm warning together with a continuous audible beep and flashing ALARM indicator light when certain parameter limits are exceeded. Two examples are shown below:

```
PRE-ALARM: 2010H  
OIL LIFE END
```

```
PRE-ALARM:  
TEMP HIGH 105°C
```

Although the compressor will continue to operate whilst signalling a pre-alarm warning, the suspect condition should be promptly investigated and rectified to avoid the inconvenience of an alarm shutdown and possible damage to the unit.

A3.2 Shutdown Fault Alarms

In the event of a fault being detected in one or more of the monitored operating parameters, the compressor will shut down automatically. An audible alarm will beep continuously and the ALARM indicator light will be illuminated. The controller will indicate “STOP” and a fault message. For example:

```
STOP:  
P HIGH 0.86MPa
```

```
STOP:  
T HIGH 110°C
```

The following table provides a guide to interpreting the fault message and remedying the problem.

Fault Message	Fault	Likely Cause	Remedial Action
T HIGH	Air end discharge temperature too high.	Poor ventilation, low oil level, wrong controller parameter settings or faulty thermostatic valve.	Check ventilation conditions, oil cooler external cleanliness, oil level, controller parameters and thermostatic valve operation.
T SENSOR FAULT	Temperature sensor failure.	Temperature sensor is faulty or its wiring is disconnected or faulty.	Check temperature sensor and its wiring.
P HIGH	Over pressure.	Discharge air pressure is too high, pressure sensor is faulty or wrong controller parameter settings.	Check discharge air pressure, pressure sensor and controller parameters.
P SENSOR FAULT	Pressure sensor failure.	Pressure sensor is faulty or its wiring is disconnected or reversed.	Check pressure sensor and its wiring.
MOTOR OVERLOAD	Main drive motor current overload.	Mains power supply voltage too low, blocked air-oil separator, blocked piping, bearing or other mechanical failure, or wrong controller parameter settings.	Check controller parameters, mains power supply voltage, air-oil separator condition, internal hose and piping flows, and motor and air end rotation.
MOTOR UNBLANCE	Main drive motor current unbalance.	Mains power supply unbalanced, motor contactor failure, wiring faulty or motor faulty.	Check mains power supply, contactors, wiring and motor.
MOTOR LACK PHASE	One or two mains power supply phases inactive.	Mains power supply, contactor or wiring faulty.	Check mains power supply, contactors and wiring.
PHASE REVERSE	Wrong phase sequence of electricity supply.	Reversed phase sequence or phase(s) off.	Check electricity supply on all three phases and reverse phase sequence rotation if necessary.

Fault Message	Fault	Likely Cause	Remedial Action
FAN OVERLOAD	Fan motor current overload.	Mains power supply voltage too low, airflow restriction, fan blade interference, fan motor faulty or wrong controller parameter settings.	Check controller parameters, mains power supply voltage, airflow path, fan blade clearance, and fan motor function.
USER MISTAKE	MAX RUN TIME value reached.	Total accumulated run time has exceeded MAX RUN TIME setting.	Set MAX RUN TIME parameter at "0000" to disable this function.
ALARM TOO LONG	ALARM LONG STOP value reached.	Run time since pre-alarm maintenance warning has exceeded ALARM LONG STOP setting.	Carry out any required maintenance and then set ALARM LONG STOP parameter at "0000" to disable this function.
VOLTAGE HIGH	Power supply voltage above HIGH VOLTAGE value.	Mains power supply voltage too high or faulty controller.	Check controller parameters and measure power supply voltage independently.
VOLTAGE LOW	Power supply voltage below LOWER VOLTAGE value.	Mains power supply voltage too low or faulty controller.	Check controller parameters and measure power supply voltage independently.
TEMP LOW	Air end (discharge) temperature too low.	Ambient temperature too low or wrong controller parameter settings.	Check ambient / ventilation conditions and controller parameters.

Appendix B Remote Start and Stop Control

B1.0 Safety

The compressor has a built-in feature that allows it to be started and stopped by remote hard-wired control supplied and installed by others. However, this feature does not include provision for remote monitoring of the compressor's status or any local alarm / annunciation that the unit is about to start or stop. The remote start and stop feature should therefore NOT be used unless the person conducting a business or undertaking involving the management or control of the plant has first implemented the following risk control recommendations especially:

- (a) Do not operate the compressor with any of its maintenance access panels open or removed.
- (b) Before opening or removing any of its maintenance access panels and / or performing any maintenance work on the compressor or connected pneumatic system: switch off the unit; isolate and tag-out the power supply; carefully release any residual air pressure from the internal air-oil receiver tank, compressed air receiver tank and any connected piping; and close the air outlet valve.

B2.0 Installation

All electrical installation, maintenance or repair work should be performed by a licensed electrician.

- (a) Make the compressor safe for maintenance work in accordance with Section B1.0 (b).
- (b) Locate terminals 1, 3 and 8 on the rear of the MAM-870 Controller as shown below.





Figure B-1 Rear View of MAM-870 Controller

- (c) Connect a normally open, non-latching, single pole, push button switch (i.e. the remote control switch) between terminals 1 and 3 using a single twisted-pair, screened data or instrumentation cable. Connect one end only of the screen to earthing terminal 8. The circuit voltage and current are 25 V DC and 20 mA, respectively.
- (d) Reinstall any components that were removed in Step (b) to give access to the rear of the controller.
- (e) Prepare the compressor for use in accordance with Section 5.0.
- (f) Follow the procedure described in Section A2.0 to change the START MODE user set parameter in the controller to the “FAR” set value.

The compressor is now ready for operation by local command via the MAM-870 Controller or by remote control via the push button switch.

B3.0 Operation

Pressing and holding the remote control switch for two seconds has the same functionality as pressing either the controller’s Start button  (if the unit is shut down) or Stop button  (if the unit is running). The remote control switch must be released (i.e. opened) and then pushed (i.e. closed) again for two seconds in order to cycle the unit to the next start or stop command.

The functionality of the push buttons on the MAM-870 Controller remains unchanged when the remote control feature is enabled.

Appendix C Sequential Control

C1.0 Safety

The compressor has a built-in feature that allows it to be interconnected with up to 15 other Senator LS and / or LSV compressors for operation as a group by sequential control to save energy. All of the compressors within the group should ideally be of the same size. The control signals are communicated by a hard-wired connection that is supplied and installed by others.

The sequencing feature does not include provision for remote monitoring of any compressor's status or any local alarm / annunciation that a unit is about to start or stop. The sequencing feature should therefore NOT be used unless the person conducting a business or undertaking involving the management or control of the plant has first implemented the following risk control recommendations especially:

- (a) Do not operate any compressor with its maintenance access panels open or removed.
- (b) Before opening or removing any of its maintenance access panels and / or performing any maintenance work on the compressor or connected pneumatic system: switch off the unit; isolate and tag-out the power supply; carefully release any residual air pressure from the internal air-oil receiver tank, compressed air receiver tank and any connected piping; and close the air outlet valve.

C2.0 Installation

All electrical installation, maintenance or repair work should be performed by a licensed electrician.

- (a) Make each compressor in the group safe for maintenance work in accordance with Section C1.0 (b).
- (b) Locate terminals 6, 7 and 8 on the rear of each MAM-870 Controller. Also, locate terminals 1, 2 and 8 on each MAM-860 Controller, if any. Refer to Figure C-1.

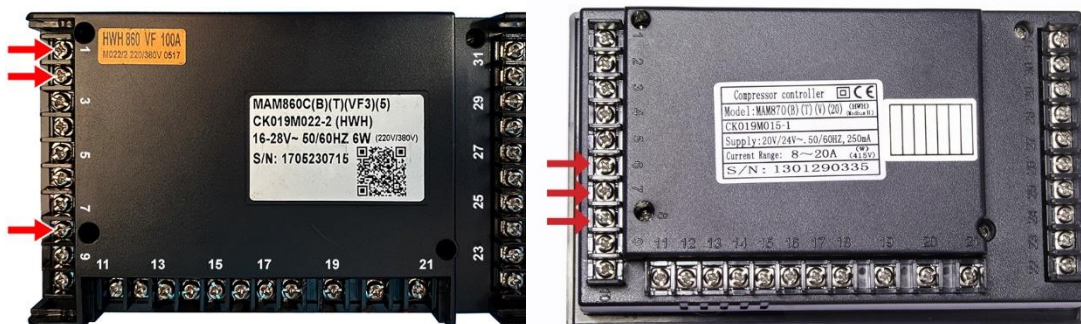



Figure C-1 Rear View of MAM-860 (Left) and MAM-870 (Right) Controllers



- (c) Connect all of the MAM-870 #6 terminals and all of the MAM-860 #1 terminals together in a daisy chain using one core of a single twisted-pair, screened data or instrumentation cable. Connect all of the MAM-870 #7 terminals and all of the MAM-860 #2 terminals together in a daisy chain using the other core. Connect one end only of the screen in each cable segment to either earthing terminal 8 (MAM-870) or earthing terminal 8 (MAM-860).
- (d) Reinstall any components that were removed in Step (b) to give access to the rear of the controllers and then prepare the compressors for use in accordance with Section 5.0.
- (e) Follow the procedures described in Appendix A for setting the controller parameters on each compressor to the correct values for interconnected sequencing operation.

C3.0 Operation

In an interconnected uniform group of all fixed speed or all variable speed compressors, assignment of the “lead” unit – i.e. the compressor which loads first and unloads last – is given to that machine with the lowest accumulated runtime at the TURN TIME or TOGGLES TIME interval defined in Appendix A.

In an interconnected mixed group of fixed and variable speed compressors, if a variable speed unit is set as the MAIN or MASTER (with a COM ADDRESS of 0001) then it will always be the lead machine. Or alternatively if a fixed speed unit is set as the MAIN or MASTER, assignment of the lead unit will be made automatically according to the lowest accumulated runtime. Setting the variable speed compressor as the master unit in such mixed groups is generally the most energy efficient solution.

To start all of the compressors in an interconnected group, press the Start button  on the master compressor only. The slave compressors will start automatically in sequence as required. Pressing the Start button  on any slave compressor starts that particular unit only with standalone functionality (i.e. not sequencing control).

To stop all of the compressors in an interconnected group, press the Stop button  on each and every compressor. Pressing the Stop button  on the master compressor stops that particular unit only and temporarily disables the sequencing control function; the other compressors in the group will continue to operate as standalone units.

The controller parameters specified in Appendix A for sequencing operation are nominal settings that are generally suitable for most applications. If, however, your interconnected group of compressors does not operate optimally – for example with periods of insufficient system pressure or excessive load / unload cycling (> 60 cycles/hour) – please contact your Senator dealer or Glenco Air & Power for specific advice.



Glenco Air & Power Pty Ltd ABN 21101370085 | **address** 19 Corymbia Place, Parkinson QLD 4115, Australia
phone 07 3386 9999 | **email** sales@glencomfg.com.au | **web** www.glencoairpower.com.au