



Instruction Manual



Senator ESV Series Air Compressor Sets with MAM-660 Controller

Revision: 2018-03-19



Introduction

Thank-you and congratulations for purchasing a high-quality Senator air compressor set. It has been designed and manufactured to provide many years of safe and reliable service if installed, operated and maintained in accordance with these instructions.

Please read and understand this manual before operating the compressor. Failure to do so could result in death, severe injury and / or substantial property damage. This manual should be considered a permanent part of the compressor and should remain with it if resold.

Disclaimers

All information, illustrations and specifications in this manual are based on the latest information available at the time of publishing. The illustrations are intended as representative reference views only. Due to our policy of continuous product improvement, we may modify information, illustrations and / or specifications to explain and / or exemplify a product, service or maintenance improvement.

We reserve the right to make any change at any time without notice. Your compressor may differ slightly from models pictured, including optional accessories.

All Rights Reserved

No part of this publication may be reproduced or used in any form by any means – graphic, electronic or mechanical, including photocopying, recording, taping or information storage and retrieval systems – without the written permission of Glenco Air & Power Pty Ltd.

Contents

1.0	Safety	1
2.0	Specifications	3
3.0	General Instructions	4
4.0	Installation	9
5.0	Operation	11
6.0	Maintenance	16
7.0	Fault Diagnosis and Repair	24
8.0	Warranty	27
Appendix A	MAM-660 Controller	29
Appendix B	C2000 Variable Speed Drive	45
Appendix C	Remote Start and Stop Control	55
Appendix D	Sequential Control	57

1.0 Safety

The air compressor should only be operated by authorised persons. All users should follow the instructions and safety warnings as (a) described in this instruction manual, (b) shown on any decals affixed to the unit and (c) described in the Plant Risk Assessment also available from the manufacturer.

All users of the compressor and any other workers likely to be in the vicinity thereof should undergo training to achieve the requisite minimum level of operator competence before placing the unit into service.

The compressor should be installed in a horizontal position on a firm, level and stationary foundation such as a concrete floor that is strong enough to support its weight. The unit should not impede pedestrian or vehicular traffic.

The compressor should be installed in a well-ventilated area preferably indoors. If it has to be located outdoors, the unit should be provided with weather protection against precipitation and direct sunlight

Do not locate the compressor where chemicals, dust, dirt, fibres, oil, salt, water or flammable / explosive liquids, gases or dusts may be present. The area should not be wet or damp. The unit should be kept away from other heat sources.

All electrical installation, maintenance or repair work should be performed by a licensed electrician.

The electricity supply circuit to the compressor should comply with the AS/NZS 3000:2007 Wiring Rules. It should include a fixed setting residual current device (RCD) with a rated operating residual current not exceeding 30 mA.

Do not use the unit to compress any gas other than air.

Compressed air can contain carbon monoxide, hydrocarbons and / or other poisonous contaminants that can cause death or serious injury. The compressor is not designed, intended or approved for breathing air. Do not use compressed air for breathing air applications without proper treatment.

Before operating the compressor, check the safety of any hoses, piping and pneumatic equipment connected to the discharge air outlet valve. Use only hoses, piping, fittings, air receivers, air tools, etc. connected to the compressor's discharge outlet valve that are safe for the unit's maximum discharge pressure (i.e. 1,000 kPa) and temperature (i.e. 100°C).

The compressor should not be operated beyond its specified design parameters, especially the maximum discharge pressure. Do not bypass or disable any of the unit's safety features.

Do not modify the compressor without written permission from the manufacturer.

Do not operate the compressor with any of its maintenance access panels open or removed.

Do not touch the external discharge pipe between the compressor module and the air receiver

tank while the compressor is running or shortly thereafter.

Do not direct a compressed air discharge stream onto a person's body.

Monitor the compressor and downstream compressed air system for any excessive noise / vibration, leaks or other abnormalities and repair any faults immediately.

Before performing any maintenance work on the compressor, switch off the unit, isolate and tag-out the power supply, carefully release any residual air pressure from the internal air-oil receiver tank, compressed air receiver tank and any connected piping, and close the air outlet valve. And if possible, allow the unit to cool down if it's been running.

Before performing any maintenance work on the compressor's variable speed drive (VSD), switch off the unit, isolate and tag-out the power supply, and wait 10 minutes. Check that the VSD's capacitors have fully discharged by measuring the DC voltage between their positive and negative terminals, which should be less than 25 V DC.

During maintenance work, take care to prevent any body parts, clothing or tools from touching any hot or moving components inside the compressor cabinet.

The maintenance access panels should be handled as a two-person lift and stored in a horizontal position when removed.

Carry out preventative maintenance on the compressor in accordance with the recommended schedule using only genuine spare parts.

Clean up any oil leak discharge or oil spill immediately.

Drain condensate from the internal air-oil receiver and external air receiver tanks only when they're depressurised. Monitor the drained condensate to check whether it poses a slip hazard, e.g. excessive condensate discharged onto a smooth, non-porous floor.

Clothing sleeves should be tight fitting, long hair should be tied back, jewellery and other loose articles should be removed, and loose gloves should not be worn when operating or maintaining the compressor.

Wear body protection such as tight-fitting gloves, long sleeves and safety boots and also eye protection such as glasses when performing any maintenance work on the compressor.

Wear eye protection such as glasses if working close to pressurised compressed air plant.

Wear protection such as a filter respirator and goggles when blowing down with compressed air. Minimise the generation of dust by compressed air blowing.

Wear appropriate eye, respiratory and body protection when spraying paint or other chemicals with compressed air. Refer to the chemical's MSDS for specific personal protective equipment (PPE) recommendations.

2.0 Specifications

Compressor Model	ESV7	ESV11	ESV15
Air Discharge (m ³ /min) @ 7 bar @ 8 bar @ 10 bar	0.48 - 1.20	0.75 - 1.88	1.05 - 2.62
	0.44 - 1.10	0.71 - 1.78	0.98 - 2.45
	0.40 - 0.99	0.63 - 1.57	0.87 - 2.17
Air Discharge Temperature (°C)	≤ Ambient + 15		
Oil Content in Discharge Air (ppm)	≤ 3 w/w		
Lubricating Oil Capacity (L)	≈ 4	≈ 8	≈ 8
Ambient Design Conditions	0°C ≤ T ≤ 45°C, P = 101.325 kPa, RH ≤ 80%		
Driving Mode	Variable Speed Electric Motor with V-Belt Drive		
Cooling Mode	Fan-Forced Oil Cooler and Air After-Cooler		
Motor Starting Mode	Electronic Variable Speed Drive		
Temperature Control Mode	Thermostatic Valve		
Input Power Supply (V / Ph / Hz)	415 / 3 / 50		
Input Power Supply (A) @ Rated PF	≈ 17.8	≈ 26.4	≈ 35.5
Main Motor Power (kW / hp)	7.5 / 10	11 / 15	15 / 20
Main Motor Speed (rpm)	1,160 ~ 2,900	1,172 ~ 2,930	1,172 ~ 2,930
Protection: Main Motor	IP55		
Fan Motor Power / Speed (kW / rpm)	0.12 / 1,300	0.12 / 1,300	0.12 / 1,300
Protection: Fan Motor	IP55		
Protection: Compressor Cabinet	IP43 with cabinet doors closed. Designed for stationary use only located either indoors or outdoors with weather protection against precipitation and direct sunlight.		
Protection: Internal Elec. Cabinet	IP22		
Noise Level @ 1 m (dB(A))	69	71	73
Discharge Air Pipe Connection	3/4" BSP Female	1" BSP Female	1" BSP Female
Air Tank Volume (L)	250	350	350
Overall Dimensions: W × D × H (cm)	133 × 94 × 143	151 × 103 × 155	151 × 103 × 155
Weight (kg)	420	563	598
Air End Pulley: Type × PCD × Grooves	7 bar SPZ × 100 × 3 *	SPZ × 140 × 3	SPZ × 125 × 4
	8 bar SPZ × 100 × 3 *	SPZ × 150 × 3	SPZ × 125 × 4
	10 bar SPZ × 100 × 3 *	SPZ × 150 × 3	SPZ × 140 × 4
Air End Pulley Taper Bush: Model × Bore	7 bar 1610 × 28	2012 × 40	2012 × 40
	8 bar 1610 × 28	2012 × 40	2012 × 40
	10 bar 1610 × 28	2012 × 40	2012 × 40
Motor Pulley: Type × PCD × Grooves	7 bar SPZ × 125 × 3	SPZ × 140 × 3	SPZ × 170 × 4
	8 bar SPZ × 118 × 3	SPZ × 140 × 3	SPZ × 160 × 4
	10 bar SPZ × 106 × 3	SPZ × 125 × 3	SPZ × 160 × 4
Motor Pulley Taper Bush: Model × Bore	7 bar 2012 × 38	2012 × 42	2517 × 42
	8 bar 2012 × 38	2012 × 42	2517 × 42
	10 bar 1610 × 38	2012 × 42	2517 × 42
V-Belts: Quantity × Type-Size	7 bar 3 × SPZ-1037	3 × SPZ-1237	4 × SPZ-1262
	8 bar 3 × SPZ-1024	3 × SPZ-1250	4 × SPZ-1237
	10 bar 3 × SPZ-1012	3 × SPZ-1212	4 × SPZ-1262

* Proprietary pulley design, not commercial off-the-shelf type.

3.0 General Instructions

3.1 Overview

The ESV Series compressor sets are stationary, single-stage, oil-lubricated rotary screw type driven by a variable speed electric motor. The compressor unit is installed above the air tank. The compressor has an advanced micro-computer controller with an LCD display. It can efficiently reduce the power consumption and provide the operator with a convenient operation, monitoring and protection interface.

3.2 System Flowchart

The compressor primarily consists of the rotary screw air end, electric motor, air-oil separator, oil system, cooling system, air system, electrical control system and other ancillary components.

The system flow diagram of the unit is shown in Figure 3-1.

The typical internal structure of an ESV Series screw compressor is shown in Figure 3-2.

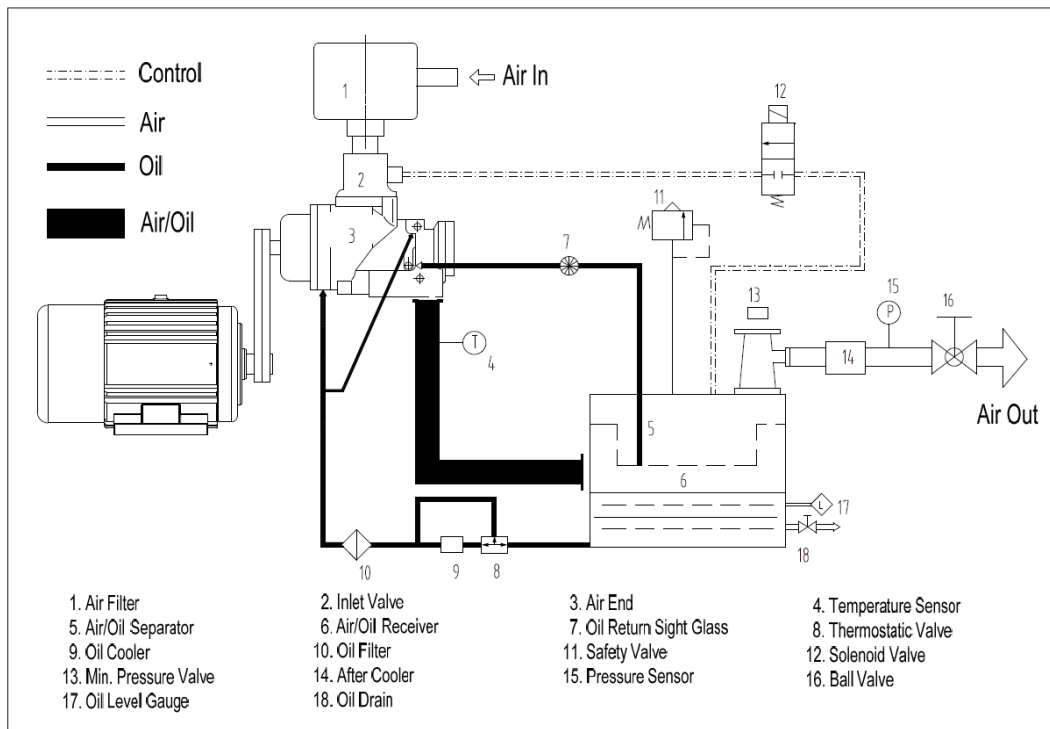

Figure 3-1 Compressor System Flowchart

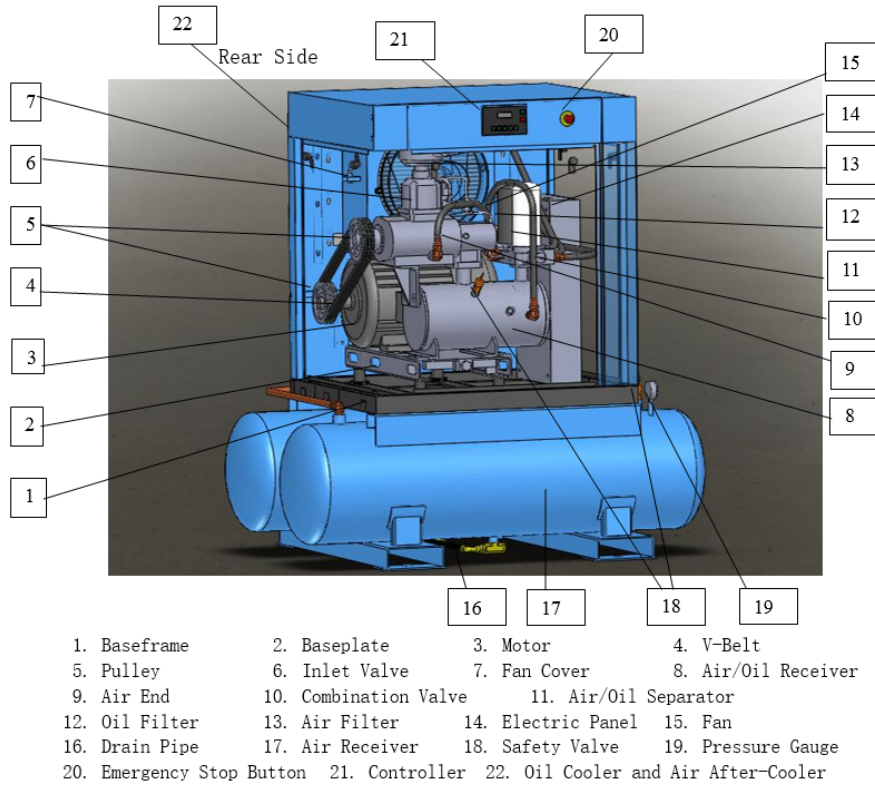

Figure 3-2 Structure of an ESV Series Air Compressor Set

3.2.1 Air System

Ambient air is drawn in via the air filter and flows through the inlet valve into the rotary screw air end for compression. Oil is continuously injected into the air end to provide both lubrication and cooling. The compressed air and oil mixture flows into the air-oil receiver for preliminary separation and then into the air-oil separator. After the air and oil are separated, the compressed air flows through the minimum pressure valve, then the after-cooler and finally into the air receiver from where it is available for discharge into the pipeline network of the user.

The function of the air filter is to remove any particulate matter such as dirt and dust to ensure that only clean air enters into the compressor’s screw air end. The inlet valve is kept fully open whenever the compressor is in “loading” mode, whereby it is pumping compressed air into the air receiver. If the pressure in the air receiver rises to a pre-programmed maximum, the compressor enters “unloading” mode whereupon the inlet valve closes fully to stop any further air being delivered into the air receiver. The electronic controller continuously monitors the pressure in the air receiver and varies the motor speed within a control range of 40 to 100% in order to maintain a pre-programmed target pressure. Adjusting the compressor’s flowrate to match fluctuating air demand without entering inefficient unloading mode is the primary means of energy saving offered by a variable speed compressor.

The inlet valve is also kept closed during compressor start-up to reduce load on the main motor. When the unit is shut down, the inlet valve is closed to prevent compressed air and oil flowing backwards from the air-oil receiver and being ejected through the air inlet.

The minimum pressure valve ensures that the pressure in the air-oil receiver doesn't fall below 0.35 MPa when the compressor is running so that the lubricating oil can flow normally in the system. When the compressor is running in unloading mode or shut down, the minimum pressure valve prevents the compressed air in the pipeline network of the user from flowing backwards into the unit.

An automatic vent valve is located beside the inlet valve. The vent valve automatically opens to release air pressure from the air-oil receiver whenever the compressor is in unloading mode or shut down.

3.2.2 Lubrication System

The compressed air and oil mixture is injected into the air-oil receiver and collides with its inner wall. Most of the lubricating oil is separated from the air-oil mixture during this process and accumulates in the lower part of the air-oil receiver. The remaining oil is captured by the air-oil separator and transferred back to the screw air end via the oil return pipe.

During compressor operation, when the temperature of the lubricating oil is below 71°C the thermostatic valve automatically opens the bypass circuit and the circulating oil from the air-oil receiver is directly injected under air pressure into the screw air end and individual lubricating points via the oil system piping and oil filter. When the temperature rises above 71°C, the thermostatic valve gradually shuts off the bypass circuit and simultaneously opens the circuit going to the oil cooler. If the temperature rises to 85°C, the bypass circuit is completely shut off and the entire lubricating oil flow from the air-oil receiver is passed through the oil cooler circuit on its way back to the air end.

The functions of the thermostatic valve are to (a) maintain constant temperature and viscosity of lubricating oil, (b) enable the system to reach the optimal operating temperature as soon as possible and (c) maintain sufficient temperature to prevent water vapour in the system from condensing. The function of the lubricating oil filter is to remove any metal wear particles and lubricating oil cracking products so as to minimise wear of the air end bearings and rotors.

3.2.3 Cooling System

Cooling air is drawn from outside the unit by the cooling fan and then blown across the radiator fins of the combined oil cooler and air after-cooler. Heat exchange takes place between the cooling air and the hot oil and compressed air streams to achieve a cooling effect. The maximum ambient air temperature should not exceed 45°C otherwise excessively high compressed air and oil temperatures will occur; this will shorten the life of the lubricating oil and may activate over-temperature shutdown of the compressor.

3.3 Control Protection System

The compressor has a micro-computer controller which automatically adjusts the operating state of the unit according to the actual air consumption of the user's application.

If the air consumption is low or the air application is paused, the main motor speed will reduce accordingly to save energy and, if necessary, the inlet valve will close to allow the compressor to operate in unloading mode. After the air consumption is recommenced, the controller will re-open the inlet valve to enable the compressor to operate in loading mode and the main motor speed will increase to match air demand. The controller monitors the compressor at all times when it's running. If any abnormal condition - such as motor overload, air discharge over-temperature, etc. - is detected, the controller automatically shuts down the compressor to protect it against damage.

A safety valve is installed in each of the air-oil and air receivers. If the pressure inside the receiver exceeds its design rating, the safety valve will automatically open to quickly discharge the air and reduce the pressure, thereby ensuring safety of the unit and personnel. The safety valves should not open during normal operation.

3.4 Electrical System

The electrical system consists primarily of the main motor, variable speed drive (for the main motor), fan motor, electrical control cabinet assembly, solenoid valve, temperature sensor, pressure sensor and controller. The electrical schematic diagram is shown in Figure 3-3.

To protect the main and fan motors against overheating damage due to abnormal conditions, the operating currents of the main and fan motors are monitored by the variable speed drive and the controller, respectively. If the motor current exceeds the allowable current, the compressor controller will perform an immediate shutdown and the motor overload alarm message will be shown on the controller's display panel.

3.5 Compressor Controller and Operation Panel

The compressor is fitted with an advanced micro-computer controller with built-in user interface. The controller handles the automatic operation, monitoring and protection of the compressor's functions.

To ensure normal and safe operation of the compressor, users should be familiar with the functions and meanings of the individual buttons, display messages and indicating lights on the controller. Please refer to the separate MAM-660 Controller Instruction Manual in Appendix A for complete details.

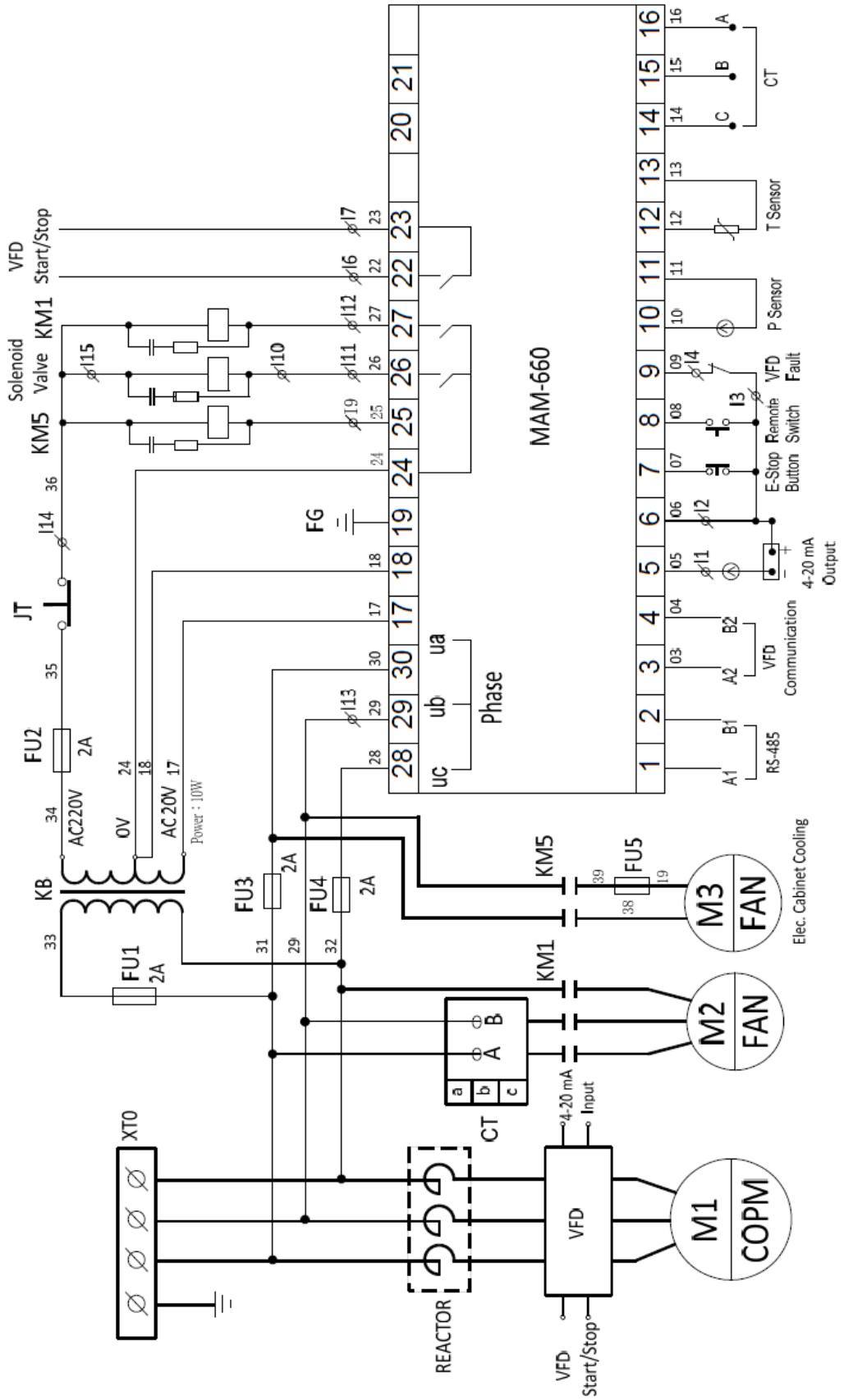
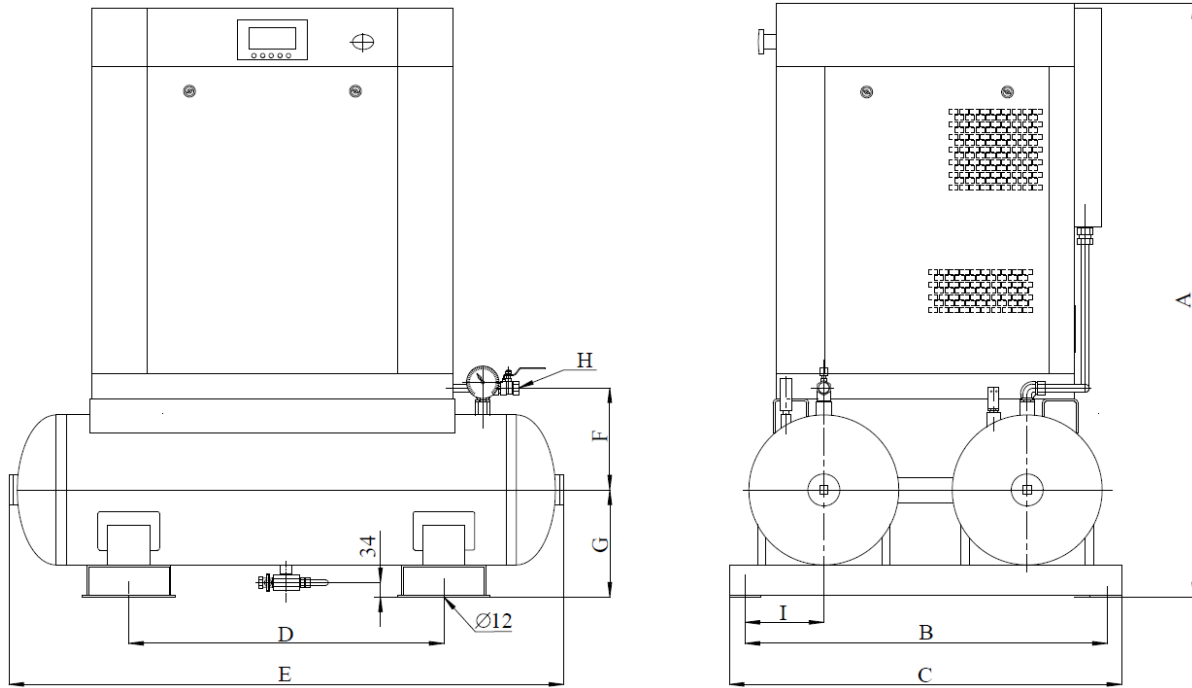

Figure 3-3 Electrical Schematic Diagram of ESV Series

4.0 Installation

4.1 Outline Dimensions



Model	A	B	C	D	E	F	G	H	I
ESV7	1,430	860	940	750	1,330	243	254	3/4" F	188
ESV11	1,550	950	1,030	750	1,510	274	280	1" F	213
ESV15	1,550	950	1,030	750	1,510	274	280	1" F	213

Figure 4-1 Outline Dimensions of ESV Series (in mm)

4.2 Installation Site of Compressor

A proper installation site should be selected for the compressor. It is recommended to use a dedicated compressor room. The installation site should meet the following requirements:

- a. It is essential to install the compressor in an area with good lighting and sufficient free space for unhindered operation and maintenance. The compressor should have a clearance of no less than 0.6 m from its front and sides, and 0.3 m from its rear. The ceiling height should be at least 2.4 m from floor level.
- b. Good ventilation is essential to ensure that the indoor ambient temperature is kept to a minimum; it should never exceed 45°C. If the compressor room is mechanically ventilated, the cooling airflow should be at least 10,000 m³/h.

- c. The ambient air should be reasonably clean and free of solid and gaseous contamination. It should have low relative humidity, low dust content and no corrosive, explosive or inflammable substances present. If the air quality fails to reach these requirements, it will be necessary to provide clean air entry to the compressor room from a remote source or install pre-filtration equipment.
- d. The compressor should be installed in a horizontal position on a solid, flat foundation. The use of flexible vibration isolators underneath the mounting feet is recommended and will reduce noise emissions. The unit is designed for stationary duty only.
- e. If it has to be located outdoors, the compressor should be provided with weather protection against precipitation and direct sunlight.

4.3 Electricity Supply

Air Compressor Model	Main Motor Rating (kW)	Main Motor Starting Method	Maximum Running Current (A)	Minimum Circuit Breaker Rating (A)	Circuit Breaker Tripping Curve
ESV7	7.5	VSD	17.8	25	B, C or D
ESV11	11	VSD	26.4	32	B, C or D
ESV15	15	VSD	35.5	50	B, C or D

- a. The compressor requires a three-phase mains power supply stabilised at 415 Volts and 50 Hertz. A portable electric generator is not recommended for powering the compressor unless it has ample generating capacity to supply both the requisite starting and running current demands without appreciable voltage or frequency drop.
- b. All electrical installation work must be performed by a licensed electrician in accordance with the AS/NZS 3000:2007 Wiring Rules.
- c. A separate electricity supply circuit is recommended for the compressor to avoid motor current overload due to excessive voltage drop or an unbalanced three-phase condition caused by other electrical equipment operating in parallel.
- d. For additional protection against electric shock, it is recommended to include a fixed setting residual current device (RCD) with rated operating residual current not exceeding 30 mA. Special RCDs should be considered for use with high current or variable speed drives (VSDs) to prevent nuisance tripping.
- e. The circuit breaker information provided in the table above is a general guide only for dedicated supply to the compressor. A four-wire conductor is required for the electricity supply, i.e. three-phase and earth only (no neutral).
- f. The maximum running current may exceed the specified value in practice if the electricity supply voltage and / or power factor are below their rated levels.

- g. If the initially connected phase sequence is incorrect, the compressor's controller will announce a "PHASE INVERT" failure. The direction of air end rotation should also be double-checked during installation by performing a "bump" test with reference to the direction-of-rotation arrow marked permanently on the air end.

5.0 Operation

Before compressor start-up, the operator should thoroughly read and understand this manual and familiarise him or her-self with the compressor's features. The operator should comply with all of the instructions and especially the safety notices.

5.1 Initial Start-Up

- a. Remove the compressor from its timber crate and shipping skid.
- b. Remove the two red shipping brackets attached between the baseframe and baseplate as shown in Figure 5-1.

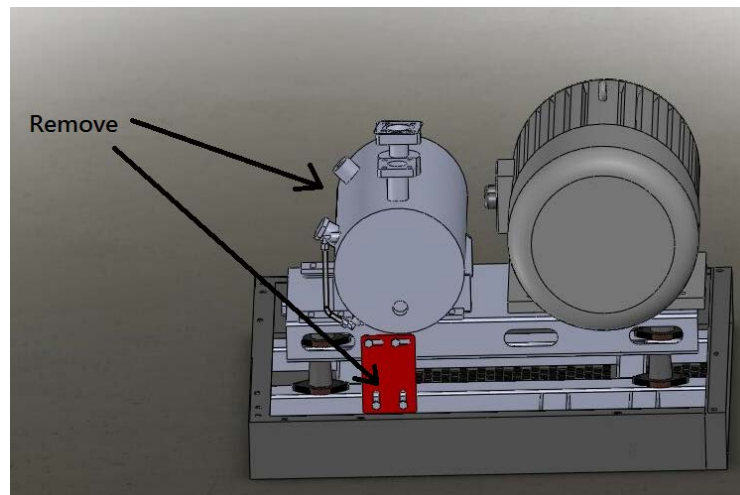



Figure 5-1 Shipping Brackets

- c. Connect the power supply cable and the earth cable (if separate). Check that the voltage is correct and equal on all three phases.
- d. Check whether the electrical wiring is safe, secure and reliable.
- e. Check whether the oil level in the air-oil receiver is OK.
- f. Check whether the V-belt tension is correct.
- g. Before start-up after three or more months of shutdown or storage, add about 0.5 L of clean compressor lubricating oil directly into the compressor through the air inlet valve and then

rotate the screw air end for several turns by hand. This is to prevent friction / heat damage to the screw air end due to insufficient lubrication upon initial start-up.

- h. At the first power-on, the power supply indicator light on the control panel will be illuminated and the current pressure in the air tank will be displayed on the control panel. If the phase sequence rotation of the power supply is incorrect, the controller will display “PHASE INVERT”. A licensed electrician must then reverse the phase sequence rotation by interchanging any two phases of the power supply connection.
- i. Open the air tank discharge valve.
- j. Rotation direction test: Although the compressor has built-in reverse phase sequence protection, the rotation direction test is still an important step in the initial start-up. It should also be carried out whenever the motor is repaired or replaced.
- k. Press the Start button  and then immediately press the Emergency Stop button when the motor shaft begins to rotate. Make sure that the rotation direction of the motor is consistent with the direction arrow marked on the air end. If it is incorrect, the phase rotation sequence of the power supply must be reversed by a licensed electrician. The rotation direction of the fan motor should also be checked; the cooling air should discharge through the oil cooler / air after-cooler and away from the exhaust duct at the rear of the unit. After completing these checks and any adjustments, release the Emergency Stop button by turning it clockwise.
- l. Re-start the compressor. The unit will automatically commence operating. Close the valve on the air receiver discharge to allow the pressure to rise until the unit starts unloading. Check whether the unloading pressure is consistent with the pre-programmed setting and observe whether the controller shows all monitored parameters are within their normal ranges. If any abnormal sound, vibration or leakage occurs, immediately press the Emergency Stop button to shut down the machine for inspection.
- m. Shutdown: Press the Stop button . The unit will enter the unloading mode and the compressor vent valve will discharge the internal system air. After 30 seconds, the unit will stop. During normal operation, do not use the Emergency Stop button to shut down the compressor.

5.2 Daily Operation

5.2.1 Start-Up

- a. Remove the plug and carefully open the ball valve at the bottom of the air-oil receiver to drain out any water condensate. Close the drain valve immediately when lubricating oil starts to flow out and then re-install the plug. This task should be undertaken when the unit is cold prior to use.

Caution: Ensure the air-oil receiver is not pressurised before removing the plug and opening the ball valve.

- b. Open the ball valve underneath the air receiver to drain out all water condensate and then

close it afterwards.

- c. Open the discharge valve on the air receiver.
- d. Turn on the power supply and start-up any peripheral compressed air equipment such as an air dryer.
- e. Press the Start button **I** on the compressor.
- f. After the operation is in steady state, check the discharge pressure and temperature readings. The pressure should remain within the limits of the “loading” and “unloading” pressure settings provided that the compressor and / or the air storage capacity is large enough for the application. The temperature will typically vary between 71 and 85°C depending upon the unit’s operating conditions, and should not exceed 104°C.
- g. Ensure that the pre-maintenance safety precautions described in Section 1.0 are taken before checking the compressor’s oil level in accordance with the instructions given in Section 6.0.
- h. If any abnormal condition is found, turn off and isolate the compressor for inspection. Only re-start the unit after rectifying the problem.

5.2.2 Operating Modes

Starting

Press the Start button **I**. The controller will signal the variable speed drive to start the main drive motor. The compressor’s inlet valve remains closed initially to minimise the load on the motor and air end.

Loading

Four seconds after starting, the solenoid actuated inlet valve opens fully so that a high volume of air can enter into the compressor to enable “loading” mode operation. When the pressure inside the air-oil receiver reaches 0.35 MPa, the minimum pressure valve opens and the unit starts to discharge into the air receiver.

The compressor’s motor speed will vary over a range of 40 to 100% as the unit tries to maintain the target pressure level in the air receiver notwithstanding fluctuations in the air demand. The target (or “VSD”) pressure can only be set within the limits of the minimum (or “loading”) and maximum (or “unloading”) operating pressures.

Unloading

If the user’s air consumption remains continuously below the compressor’s minimum discharge flowrate, the discharge pressure of the unit will reach the set unloading pressure. At this point, the inlet valve closes to stop air input. The check valve spool of the minimum pressure valve is closed to isolate the compressor from the pipeline of the user. The vent valve opens to reduce

the pressure in the air-oil receiver down to approximately 0.4 MPa, thereby reducing the operating back pressure within the compressor's air circuit and maintaining lubricating oil circulation.

In unloading mode, if the discharge pressure reduces to the loading pressure set point, the controller actuates the solenoid to open the inlet valve and close the vent valve. The unit is thus returned to the loading operation state.

If the unit fails to stop loading operation at the correct unloading set point pressure, it may cause the safety valve installed in the air-oil receiver to open for system pressure relief, thereby avoiding any hazard due to excessively high system pressure. If this occurs, immediately shut down the unit and check the inlet valve and controller for their correct operation and setting.

Stand-By



If the compressor operates continuously in unloading mode for five minutes, the controller assumes that the user has ceased air consumption and switches the compressor to stand-by mode. The main motor and fan motor will stop rotating to save energy.

In stand-by mode, if air consumption is resumed and pressure in the air receiver decreases to the loading set point, the controller will re-start the unit automatically.

Caution: The controller's display will indicate "EMPTY STOP" whenever the compressor is in stand-by mode. In such a state, the compressor cabinet doors should not be opened and no maintenance work should be carried out due to the risk of injury if the unit re-starts automatically.

5.2.3 Shutdown

Normal Shutdown

If compressed air is no longer required, for example at lunchtime or end of the working day, pressing the Stop button  will initiate the compressor's normal shutdown sequence. The unit will either switch to or remain in unloading mode for 30 seconds to stabilise the internal air and oil systems before ceasing operation altogether. After a further 60 seconds, the unit can only be re-started by pressing the Start button .

After shutdown, the air tank discharge valve should be closed to protect the unit against the influence of compressed air in the external pipeline network.

Caution: The compressor VSD's cooling fan will continue to operate for one minute after the compressor has shut down. Do not switch off or disconnect the unit's power supply during this time except in the case of emergency or for urgent maintenance.

Fault Alarm Shutdown

If any electrical, pressure or temperature fault is detected, the controller will shut down the compressor immediately. If this happens, the fault should be investigated and rectified according to the indication on the controller's display panel. Press and hold the controller's Return / Reset button marked "C" for 5 seconds to reset the compressor after rectifying the fault or alternatively switch off the mains electricity supply for one minute.

Emergency Shutdown

If any abnormal condition arises during compressor operation, press the Emergency Stop button immediately for direct shut down of the unit to avoid any damage or injury. The fault should then be investigated and rectified before resetting the controller.

5.2.4 Monitoring During Operation

- a. Observe whether the compressor is emitting any abnormal noise or vibration. If present, an immediate shutdown should be performed.
- b. Do not loosen any pipes, bolts, threaded joints or electrical connections in the compressor when it's switched on or running. Any individual valves in the unit shouldn't be opened or closed at random.
- c. Observe the oil level. If the oil level is too low and not in the green zone on the oil level gauge, shut down the compressor and top-up the oil level.
- d. The operator on each shift should keep a written log recording the discharge pressure, discharge temperature, power supply voltage, motor currents, oil level, run time, etc. and any maintenance or repair work carried out on the compressor.

5.2.5 Duty Cycle

The compressor is ideally suited for applications with a fluctuating compressed air demand of between 40 and 100% of the unit's rated free air delivery.

During periods of very low air demand, the unit may not reach its normal operating temperature with sufficient frequency or duration. Sustained operation at very low duty cycle can result in a build-up of water condensate within the lubricating oil. If this occurs, the lubricating characteristics of the oil can be impaired and this may cause serious internal damage to the unit.

The compressor should be allowed ample running time in loading mode of at least 10 minutes per hour when in use to prevent such accumulation of condensate in the lubricating oil.

5.3 Long-Term Shutdown

5.3.1 Preparation

If the compressor is to be shut down for longer than one month, the following steps should first be performed:

- a. Any faults should be rectified in preparation for the unit's future use.
- b. The water condensate in the air-oil receiver and air receiver tanks should be completely drained out to prevent internal corrosion.
- c. All openings should be enclosed with plastic cloth or oiled paper to prevent the ingress of moisture and dust.

If the unit is to be out of service for more than two months, replace the lubricating oil beforehand and then run the compressor for 30 minutes. After three days, the water condensate in the air-oil receiver should be completely drained out.

5.3.2 Re-start

- a. Remove the protective plastic cloth or oiled paper.
- b. Measure the insulation resistance of motors to ground, which should be more than 1 MΩ.
- c. Follow the initial start-up procedure described in Section 5.1 to re-start the unit.

6.0 Maintenance

Before performing any maintenance work on the compressor, switch off the unit, isolate and tag-out the power supply, carefully release any residual air pressure from the internal air-oil receiver tank, compressed air receiver tank and any connected piping, and close the air outlet valve. And if possible, allow the unit to cool down if it's been running.

6.1 Lubricating Oil

The lubricating oil has a critical effect on the performance and service life of a rotary screw air compressor. If incorrect lubricating oil is used, it will cause severe damage to the compressor. Either of the following compressor lubricating oils is recommended:

Option 1: Compressor Oil – Mineral Based
Brand: Castrol
Product: AIRCOL PD46
Service Life: Up to 2,000 Hours

Option 2: Synthetic Compressor Oil - Polyalphaolefin Based
Brand: Castrol
Product: AIRCOL SR46
Service Life: Up to 8,000 Hours

Equivalent premium grade compressor oils from other suppliers may be substituted.

Caution: Use only one or the other of the above recommended oil types. Do not use a mixture of mineral and synthetic oils.

6.1.1 Oil Change Interval

- a. The initial oil change should be performed after the compressor operates for about 500 running hours or 3 months, whichever occurs first.
- b. If mineral-based lubricating oil is used, it should be replaced every 1,000 to 2,000 hours. If synthetic-based oil is used, it should be replaced every 4,000 to 8,000 hours. In either case, the lubricating oil should be replaced at least every 12 months if not sooner according to the running hours limit.
- c. If an oil sample analysis indicates that the lubricating oil needs to be changed, it should be done promptly.
- d. If the operating conditions are poor and the discharge temperature is often 95°C or higher, the oil change period should be halved.

6.1.2 Replacing Oil

- a. Press the Stop button  and then switch off, isolate and tag-out the power supply to the compressor.
- b. Close the air receiver discharge valve. Release any pressure from the air receiver by carefully opening the drain valve and monitor the pressure gauge to confirm.
- c. Wait at least two minutes for the pressure in the air-oil receiver to be completely released and monitor the pressure gauge to confirm. Slowly open the screw-plug at the oil filling port and then rotate the air end pulley by hand about 10 turns in the forward direction as marked on the air end.
- d. Remove the plug from the outlet of the oil drain ball valve and then open the valve to drain out the lubricating oil from the air-oil receiver. Collect the drained lubricating oil in a suitable container and properly dispose of it to prevent any environmental pollution.
- e. Close the oil drain ball valve and reinstall the oil drain plug. Fill the air-oil receiver with lubricating oil until the oil level reaches the upper limit of the green zone on the oil level gauge. Reinstall and tighten the screw-plug in the oil filling port.
- f. Re-start the compressor and allow it to operate in loading mode until the discharge

temperature reaches at least 75°C and then shut down the unit. Wait five minutes and re-check the oil level. Top-up if necessary until the oil level is at the top-dead-centre mark on the gauge as shown in Figure 6-1.

- g. Reset the “LUBE” hours to zero via the user set parameters menu of the controller.



Figure 6-1 Full Oil Level Indication

6.2 Oil Filter

Initial replacement of the oil filter should be performed after the compressor operates for 500 hours or 3 months, whichever occurs first. Subsequent replacement is required every 1,000 hours or 12 months. If the lubricating oil needs to be replaced, the oil filter should be replaced at the same time. If the operating conditions are poor and the discharge temperature is often 95°C or higher, the oil filter replacement period should be halved. The replacement steps are as follows:

- a. Press the Stop button  and then switch off, isolate and tag-out the power supply to the compressor.
- b. Close the air receiver discharge valve. Release any pressure from the air receiver by carefully opening the drain valve and monitor the pressure gauge to confirm.
- c. Wait at least two minutes for the pressure in the air-oil receiver to be completely released and monitor the pressure gauge to confirm.
- d. Use an oil filter wrench to remove the oil filter by unscrewing it anticlockwise.
- e. Clean the sealing washer of the new oil filter and then apply a thin layer of clean lubricating oil onto it.
- f. Install the new oil filter by screwing it on clockwise until the sealing washer contacts the oil filter base and then tighten it by hand a further ½ to ¾ of a turn.
- g. Reset the “OIL FILTER” hours to zero via the customer set parameters menu of the controller.

6.3 Air-Oil Separator

The air-oil separator should be replaced after every 2,000 hours or 1 year, whichever occurs first. In a dirty or dusty environment, the replacement period should be halved. It is not possible to clean the air-oil separator element, only replacement is allowed.

The procedure for replacing the air-oil separator is essentially the same as that described above for replacing the oil filter.

Caution: When removing the air-oil separator, the separator connector may become partly or wholly unscrewed from its base. Use a spanner to check and tighten the separator connector if necessary, taking care not to damage its sealing O-rings.

Caution: When replacing the air-oil separator, it is essential to prevent ingress of foreign matter into the air-oil receiver.

After replacing the air-oil separator, reset the “O-A FILTER” hours to zero via the customer set parameters menu of the controller.

6.4 Air Pre-Filters

The air pre-filters are accessed by removing the compressor’s side panels. Refer to Figure 6-2.

Wash the foam elements in warm, soapy water and then rinse clean. Do not use any solvents or chemical cleaners.

Shake the foam elements to remove excess water and then blow dry using compressed air or allow to dry naturally before re-installation. Do not operate the unit with the air pre-filters or side panels removed.



Figure 6-2 Air Pre-Filters Removal

6.5 Air Filter

- a. After removal from the air filter assembly and working at a distance of at least 5 m from the compressor, the air filter element can be blown clean from the inside to the outside using compressed air at a pressure no higher than 500 kPa. Refer to Figure 6-3. Keep the air blowing outlet more than 20 mm away from the inner surface of the filter element. After the air filter element is cleaned 3 to 4 times, it should be replaced.



Figure 6-3 Air Filter Element Cleaning

- b. Do not hit the air filter element to shake free any dust nor clean it with water or any other liquid. If the filter element is damaged, it should be replaced. If the filter element is oily or contaminated severely, no cleaning is practicable and the element should be replaced.
- c. The maximum service life of the air filter element is 2,000 hours. If the operating conditions of the compressor are adverse (i.e. dusty or dirty), then the replacement period should be halved.
- d. After replacing the air filter element, reset the “AIR FILTER” hours to zero via the customer set parameters menu of the controller.

6.6 Oil Cooler and Air After-Cooler

If the air discharge temperature from the compressor is excessively high, the combined oil cooler and air after-cooler mounted on the rear of the compressor cabinet should be blown off with clean compressed air to remove any dirt or dust. If it can't be cleaned in this manner, then wash it with a proper cleaning agent. Never use a metal wire brush or metal scraper to remove the dirt or dust. The finned cooler should be kept clean and free of any obstructions at all times.

6.7 Safety Valves

Regularly check the safety valves on the air-oil receiver and the air receiver to verify that they're operating freely. While the receiver is pressurised to at least 650 kPa (94 psi), pull the ring on the safety valve and allow it to snap back to its normal position. If air leaks out after the ring has been released, or the valve is stuck and cannot be actuated by pulling the ring, the safety valve is faulty and must be replaced before operating the compressor.

Caution: Take care when testing the safety valve as compressed air will discharge from the valve with high velocity.

Caution: Do not tamper with the safety valve. It is designed to automatically release air if the receiver pressure exceeds the safety valve's pressure setting.

6.8 V-Belts

- a. Check the condition and tension of the V-belts after the compressor operates for about 500 running hours or 3 months, whichever occurs first, and thereafter each 1,000 running hours or 1 year. If correctly tensioned, a force of 40 to 60 N (4 to 6 kg) applied mid-span on a single V-belt should cause it to deflect about 12 mm ($\approx 1/2$ inch).
- b. It is essential to use replacement V-belts with the correct specifications. Replace all V-belts simultaneously and do not mix belts from different manufacturers. Also, do not mix new and used V-belts.
- c. To adjust the V-belt tension, the four fixing bolts under the main motor should be slightly loosened at first, and then the adjustment screw can be turned to move the main motor to tension the V-belts. After adjustment, the fixing bolts holding down the main motor should be retightened. Refer to Figure 6-4.
- d. When carrying out maintenance on the compressor, do not allow any oil or other liquids to splash onto the V-belts or pulleys to prevent belt slippage.

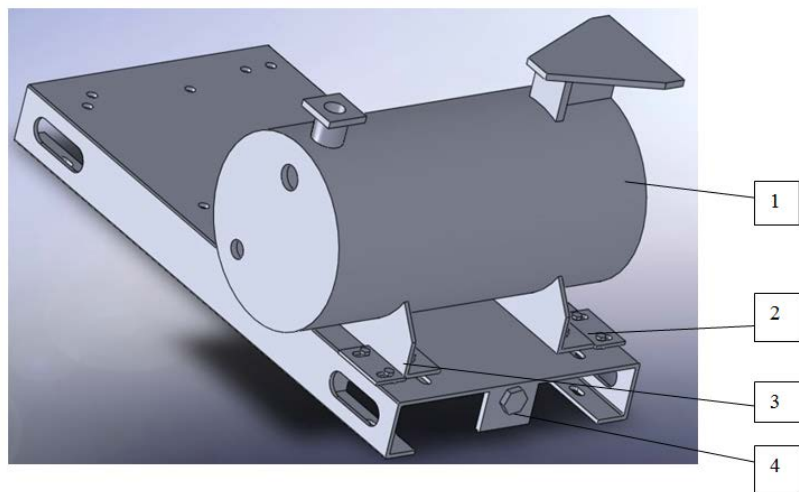

1. Air/Oil Receiver 2. Guide Plate 3. Fixing Bolt 4. Adjustment Bolt

Figure 6-4 V-Belt Tension Adjustment

6.9 Motor Bearings

The main motor's drive end (DE) and non-drive end (NDE) bearings on Models ESV11 and ESV15 should be re-greased at least every 2,000 hours or 1 year, whichever occurs first. Mobil Polyrex EM grease or equivalent is recommended. Do not mix different types of grease. This maintenance task is best undertaken when the motor is still warm to allow for better dispersion of the grease.

- a. Locate the grease nipple on top of each DE and NDE bearing and also the grease drain plug underneath (that may be offset to one side). Refer to Figure 6-5. It is often necessary to temporarily remove the motor fan cowl on the non-drive end to access these points.
- b. Remove the drain plug and clean old grease from the drain opening.
- c. Clean the grease nipple and grease gun nozzle to prevent contaminants entering into the bearing.
- d. Using a hand operated grease gun, pump the requisite quantity of grease in through the nipple as specified on the motor bearing data nameplate.
- e. Operate the compressor for 10 to 30 minutes with the drain plug removed to allow any excess grease to vent out through the drain.
- f. Shut down the compressor and make it safe to work on again. Then clean up any expelled grease from the drain outlet and re-install the plug.



Figure 6-5 Motor Bearing Re-Greasing

6.10 Electrical Cabinet and VSD

The compressor's electrical cabinet and the components housed therein including the VSD should be cleaned by a licensed electrician every 2,000 hours or 1 year, whichever occurs first. The external and internal surfaces of the electrical cabinet should be vacuum cleaned and wiped down with a dry cloth. The electrical components and wiring within the cabinet should be vacuum cleaned only with particular attention given to the cabinet's cooling fan and integrated air filter and also the external surfaces and cooling air vents of the VSD.

6.11 Preventative Maintenance Program

Maintenance Task	Maintenance Interval *						
	8 h	40 h	500 h	1,000 h	2,000 h	4,000 h	8,000 h
	Daily	Weekly	Qtrly	1 Year			2 Years
Routine Operation							
Check / Top-Up Oil Level	•						
Drain Air-Oil Receiver Condensate	•						
Drain Air Receiver Condensate	•						
Check Controller and Gauge Readings	•						
Air System							
Clean Air Pre-Filters			•				
Clean Air Filter Element			•				
Clean Oil Cooler and Air After-Cooler			•				
Check Safety Valves				•			
Replace Air Filter Element					•		
Replace Inlet Valve Maintenance Kit							•
Replace Minimum Pressure Valve Maintenance Kit							•
Air-Oil Receiver Ext. Inspection							•
Air Receiver External Inspection							•
Air Receiver Internal Inspection							•
Oil System							
Replace Oil Filter			• Initial	•			
Replace Oil			• Initial		• ¹		• ²
Replace Air-Oil Separator					•		
Replace Thermostatic Valve Maintenance Kit							•
Drive System							
Check / Adjust V-Belt Tension			• Initial	•			
Replace V-Belts							•
Re-Grease Motor Bearings					•		
Electrical System							
Check Emergency Stop Button			•				
Check Electrical Connections					•		
Clean Electrical Cabinet and VSD					•		
Check Motor Insulation (> 1 MΩ)						•	

* Compressor running hours or elapsed time period, whichever occurs first. In adverse working conditions, such as dusty environment and / or high temperature, the maintenance intervals should be halved.

¹ Using mineral-based compressor lubricating oil; 2,000 hours maximum or 1 year.

² Using synthetic-based compressor lubricating oil; 8,000 hours maximum or 1 year.

6.12 Dismantling and Disposal

There is no requirement for the compressor to be dismantled during normal operation other than for major repair / overhaul or prior to final disposal at the end of its service life. Dismantling should only be carried out by a mechanically proficient person with access to proper tools or alternatively by an authorised Senator dealer for a fee. The air-oil receiver tank should be rendered unusable for pressure service prior to disposal, for example by cutting or massive deformation. This is to prevent its unauthorised and unsafe use by others.

Do not pollute the environment by improper or illegal disposal of the waste oil or condensate. Similarly, do not pollute the environment by improper or illegal disposal of the compressor either as a whole or dismantled. Take the unwanted unit or components to your local recycling centre instead. The compressor is almost entirely made of metal that can usually be sold to scrap metal recyclers.

7.0 Fault Diagnosis and Repair

7.1 Compressor Fault Analysis

Please refer to this section for assistance with fault diagnosis and repair in the unlikely event that any problem might occur with your air compressor.

It is important to collect operating data about the unit routinely and systematically. Based on this data, the operator can more readily detect any changes in the unit's performance and possibly identify any actual or potential faults.

Before repairing or replacing any components, the various factors that may cause a particular fault should be investigated in detail to identify the exact reason if possible. Don't disassemble or move the compressor unit in a disorderly way, otherwise unnecessary damage may be caused.

Routine observations should be logged of the following inspections:

- a. Whether any wiring connections/terminals are loose or disconnected.
- b. Whether any piping is damaged.
- c. Whether any components are damaged due to over-heating or short circuiting. An obvious tell-tale sign is discoloration or a burning odour.
- d. Whether any air or oil leakage is evident.
- e. Whether any abnormal noise is audible.
- f. Whether any abnormal vibration is detectable.
- g. Whether any messages / readings shown on the controller display or other gauges deviate from their regular values.

7.2 Troubleshooting Chart

Symptom	Possible Cause	Corrective Action
Compressor fails to start-up.	<ol style="list-style-type: none"> 1. Mains electricity supply is not switched on or functioning. 2. Electricity supply voltage is too low. 3. Electricity supply is not functioning on all three phases. 4. Loose wiring or poor contact. 5. Motor failure. 6. Air end failure. 	<ol style="list-style-type: none"> 1. Check mains electricity supply is switched on and live at the compressor's incoming terminals. 2. Investigate and rectify electricity supply voltage. 3. Investigate and rectify electricity supply on all three phases. 4. Check and tighten all electrical connections. 5. Repair or replace motor. 6. Repair or replace air end.
Air discharge temperature is too high ($\geq 105^{\circ}\text{C}$).	<ol style="list-style-type: none"> 1. Insufficient lubricating oil. 2. Too high ambient temperature. 3. Oil cooler fins are blocked. 4. Oil filter is blocked. 5. Thermostatic valve is faulty. 6. Incorrect grade of lubricating oil. 7. Cooling fan is faulty. 8. Temperature sensor is faulty. 	<ol style="list-style-type: none"> 1. Check oil level in air-oil receiver. 2. Improve ventilation conditions and reduce room temperature. 3. Clean oil cooler fins. 4. Replace oil filter. 5. Check whether oil is cooling down via oil cooler. If not, repair or replace thermostatic valve. 6. Change to correct grade of lubricating oil. 7. Repair or replace cooling fan and fan motor. 8. Check or replace temperature sensor.
Air discharge temperature is too low ($\leq 71^{\circ}\text{C}$).	<ol style="list-style-type: none"> 1. Very low ambient temperature. 2. Thermostatic valve is faulty. 3. Temperature sensor is faulty. 	<ol style="list-style-type: none"> 1. Change ventilation conditions and increase room temperature. 2. Repair or replace thermostatic valve. 3. Check or replace temperature sensor.
Air supply pressure (to user's air piping network) is too low.	<ol style="list-style-type: none"> 1. Pressure settings are too low. 2. Air consumption is greater than compressor output. 3. Air filter is blocked. 4. Inlet valve isn't opening fully. 5. Pressure sensor is faulty. 6. Minimum pressure valve is faulty. 7. Air-oil separator is blocked. 	<ol style="list-style-type: none"> 1. Check the controller's pressure settings. 2. Reduce air consumption and / or check air piping system for leakage. 3. Clean or replace air filter element. 4. Check the action of inlet valve. 5. Check or replace pressure sensor. 6. Repair or replace minimum pressure valve. 7. Check or replace air-oil separator.
Air supply pressure (to user's air piping network) is too high.	<ol style="list-style-type: none"> 1. Pressure settings are too high. 2. Air system unloading components are faulty, e.g. solenoid valve, inlet valve and vent valve. 3. Leakage in control air piping. 4. Pressure sensor is faulty. 	<ol style="list-style-type: none"> 1. Check the controller's pressure settings. 2. Check, repair or replace unloading components. 3. Check and rectify leakage. 4. Check or replace pressure sensor.

Symptom	Possible Cause	Corrective Action
Air discharge pressure (to the air-oil receiver) is too high.	<ol style="list-style-type: none"> 1. Pressure settings are too high. 2. Air system unloading components are faulty, e.g. solenoid valve, inlet valve and vent valve. 3. Leakage in control air piping. 4. Air-oil separator is blocked. 5. Minimum pressure valve is faulty. 6. Pressure sensor is faulty. 	<ol style="list-style-type: none"> 1. Check the controller's pressure settings. 2. Check, repair or replace unloading components. 3. Check and rectify leakage. 4. Check or replace air-oil separator. 5. Repair or replace minimum pressure valve. 6. Check or replace pressure sensor.
Compressed air has relatively high oil content and oil refilling period is shortened.	<ol style="list-style-type: none"> 1. Oil level in the air-oil receiver is too high. 2. Filter or orifice in the oil return pipe or the pipe itself is blocked. 3. Air-oil separator element or O-ring is damaged. 4. Leakage in oil piping. 5. Oil is wrong grade causing excessive foaming. 	<ol style="list-style-type: none"> 1. Check oil level and drain out any excess. 2. Clean or replace filter element, orifice and pipe. 3. Check or replace air-oil separator element, O-ring and tightness of connector. 4. Check and rectify leakage. 5. Replace oil with correct grade.
Oil mist leaks out of air filter during shutdown.	<ol style="list-style-type: none"> 1. Nil or insufficient operation in unloading mode before shut down. 2. Solenoid valve, inlet valve or vent valve is faulty. 3. Venting of air-oil receiver is incomplete. 4. Minimum pressure valve is faulty. 	<ol style="list-style-type: none"> 1. Check and follow correct procedure for normal shut down. Check the controller's time settings 2. Check or replace solenoid valve, inlet valve or vent valve. 3. Check vent valve. 4. Repair or replace minimum pressure valve.
Switching between unloading and loading modes is too frequent.	<ol style="list-style-type: none"> 1. Air piping leakage. 2. The differential between the unload and load pressure settings is too small. 3. Air consumption and system air pressure fluctuate excessively. 	<ol style="list-style-type: none"> 1. Check and rectify air leakage. 2. Check the controller's pressure settings. 3. Increase air storage capacity in the user's piping network.

8.0 Warranty

8.1 Proof of Purchase

Please complete the following details about your air compressor for future reference regarding warranty, spare parts and service.

Date Purchase:

Purchased From:

Tax Invoice Number:

Air Compressor Model Number:

Air Compressor Serial Number:

Air Receiver Tank Serial Number:

It is recommended that you keep a copy of the original tax invoice with this manual.

8.2 Warrantor

Name: Glenco Air & Power Pty Ltd
(ABN 21101370085)

Address: 21 Resource Street, Parkinson, QLD, 4115, Australia

Phone: (07) 3386 9999

Fax: (07) 3386 9988

Email: sales@glencomfg.com.au

Web: www.glencoairpower.com.au

8.3 Warranty Conditions

Glenco Air & Power Pty Ltd (the “Company”) warrants that the Goods shall be free from defects in material and workmanship for a period of twelve (12) months from the date of original sale (hereinafter the “Warranty Period”).

The Warranty Period is continuous from the date of original sale and does not re-start upon the repair or replacement of the Goods or any part thereof.

Upon return – transportation charges prepaid by the Consumer – to the Company’s or its nominated dealer’s premises within the Warranty Period, the Company shall repair or replace,

at its option, any Goods which it determines to contain defective material or workmanship, and shall return said Goods to the Consumer free-on-board (FOB) at the Company's or agent's premises. The repair or replacement work will be scheduled and performed according to the Company's normal work flow and availability of replacement parts.

The Company shall not be obligated, however, to repair or replace Goods which have been: repaired by others; abused; improperly installed, operated, maintained, repaired, transported or stored; not serviced to schedule using genuine spare parts; altered or otherwise misused or damaged in any way.

The Company shall not be responsible for any diagnosis, communication, dismantling, packing, handling, freight, and reassembly or reinstallation charges.

Freight damage, pre-delivery service, normal operating adjustments, preventative maintenance service, consumable items, cosmetic damage, corrosion, erosion, normal wear and tear, performance, merchantability, and fitness for a particular purpose are not covered under this Warranty. Consumable items include lubricants, filters and V-belts.

The Company shall not be liable for any repairs, replacements, or adjustments to the Goods or any costs of labour performed by the Consumer or others without the Company's prior written approval.

To the extent permissible by law and notwithstanding any other clause in these Warranty Conditions, the Company excludes all liability whatsoever to the Consumer arising out of or in any way connected with a contract for any consequential or indirect losses of any kind howsoever arising and whether caused by breach of statute, breach of contract, negligence or other tort.

The Company's liability will be limited to, in the case of products, the replacement of the products, the supply of equivalent products or the payment of the cost of replacing the products or of acquiring equivalent products or, in the case of services, the supply of the services again or the payment of the cost of having the services supplied again. The choice of remedy will be at the discretion of the Company and the Consumer acknowledges that this limitation of liability is fair and reasonable.

This Warranty is available only to the original Consumer bearing the original tax invoice from the Company or one of its authorised dealers as proof of purchase. Goods purchased from any other party such as a private seller, auction house, eBay seller, etc. are not covered by this Warranty.

Our goods come with guarantees that cannot be excluded under the Australian Consumer Law. You are entitled to a replacement or refund for a major failure and compensation for any other reasonably foreseeable loss or damage. You are also entitled to have the goods repaired or replaced if the goods fail to be of acceptable quality and the failure does not amount to a major failure.

Appendix A MAM-660 Controller

A1.0 Basic Operation

A1.1 Description of Keypad

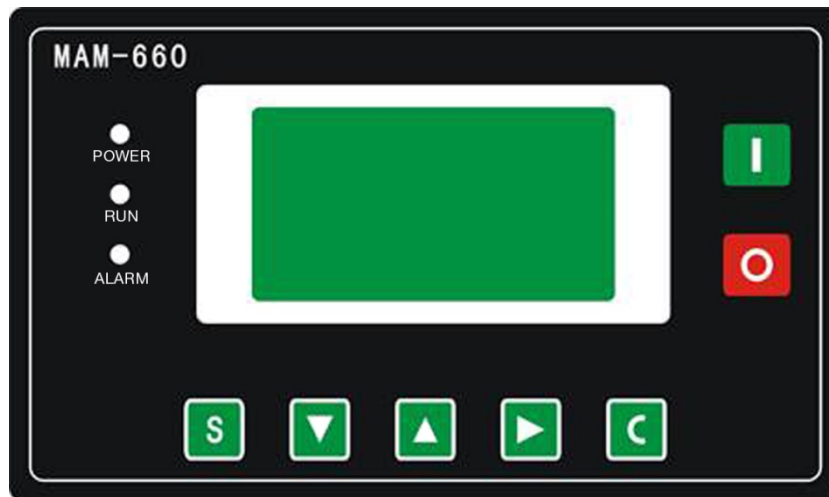

I - Start Button. Press this button to start the compressor. The unit will start running immediately unless it's in a delay countdown after an earlier manual or automatic shutdown as shown on the controller's display.

O - Stop Button. Press this button to stop the compressor for a normal shutdown. If running, the unit will immediately switch to unloading mode and initiate a delay countdown as shown on the controller's display before switching off entirely. If stopped after an earlier automatic shutdown, pressing the Stop button will disable the automatic re-start function until the Start button is pressed again.

S - Set Button. Press this button to confirm the data input and save it after modification. When the compressor is running in automatic mode, pressing this button will switch the unit to manual load / unload operation; this feature should not be used in normal conditions.

▼ - Down Button. Press this button to move downward during data modification. Press this button to select the next menu during menu selection.

▲ - Up Button. Press this button to move upward during data modification. Press this button to select the next menu during menu selection.

▶ - Cursor / Confirm Button. This button can be used as a cursor during data modification and as a confirmation during menu selection.

C - Return / Reset Button. Press this button to return to an upper menu during menu selection.

Press and hold this button for 5 seconds to reset the compressor when the unit is stopped after alarm shutdown.

POWER Indicator. The red light is illuminated continuously whenever the compressor's electrical power supply is switched on.

RUN Indicator. The green light is illuminated continuously whenever the compressor is running.

ALARM Indicator: The red light flashes accompanied by a continuous audible beep whenever the controller detects a warning or pre-alarm condition, e.g. oil filter overdue for replacement. The red light is illuminated continuously accompanied by a continuous audible beep whenever the controller detects an alarm condition and prevents the compressor from starting or shuts it down if already running, e.g. electrical supply phase reversal, high temperature, etc.

A1.2 Status Display and Operation

The display interface appears as follows when the compressor is first switched on:

<p>WELCOME USING SCREW COMPRESSOR</p>

The status display will change after 5 seconds to the following standard layout:

T: 25°C	0.0Hz
P: 0.00MPa	RPM
NORMAL STOP	
0.0V	0.0KW

The "T" value is the air end discharge temperature.

The "P" value is the air receiver pressure.

The Hertz (Hz) value is the electricity supply frequency to the main motor from the Variable Speed Drive (VSD).

The RPM value is the main motor rotational speed.

The Volts (V) value is the electricity supply voltage to the main motor from the VSD.

The kilowatts (KW) value is the electrical power input to the main motor from the VSD.

During normal compressor operation, the third line of the display will indicate the status of the

unit as described in the following table.

Status Display	Status Description
NORMAL STOP	The compressor is shut down and can only be started by pressing the Start button.
VF START ****S	The compressor has started running from a standstill and will automatically enter loading mode when required after **** seconds.
AUTO LOADING	The compressor is running automatically in loading mode.
AUTO UNLOADING	The compressor is running automatically in unloading mode after having reached the unload pressure setting.
EMPTY STOP ****S	The compressor has been running continuously in unloading mode for longer than the preset maximum and has now shut down automatically. After **** seconds, the unit will enter the standby mode. The unit will automatically re-start if the air pressure drops to the load pressure setting.
DELAY STOP *****S	The Stop button has been pressed while the compressor was running and the unit will automatically shut down in ***** seconds.
NORMAL STOP *****S	The compressor has been shut down by pressing the Stop button and will not automatically re-start. After ***** seconds, the unit can be re-started manually by pressing the Start button.
FAIL TO STOP *****S	The compressor has shut down automatically because of a fault condition. After ***** seconds, the unit can be re-started manually by pressing the Start button if the fault condition has been rectified.
EMERGENCY STOP	The Emergency Stop button has been pressed. When safe to do so, the compressor can be re-started manually after the Emergency Stop button has been released, any countdown time has elapsed (e.g. NORMAL STOP *****S) and any fault condition has been rectified.

Note: In the above table, the symbol “*” represents a whole number between 0 and 9.

A1.3 Run Parameter Review

During normal compressor operation, press the ▼ button to display the following menu:

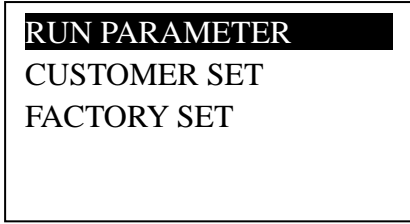

With the black cursor on the RUN PARAMETER selection, press the ► button to display the first run parameter sub-menu:



Pressing the ▼ button four times will display the second run parameter sub-menu:

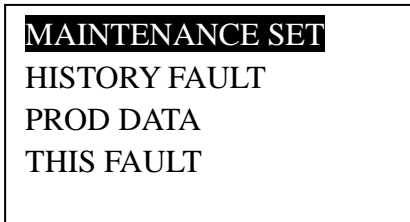

With the black cursor on the selected run parameter item, pressing the ► button will display the corresponding run parameter value(s) as described in the table below.

Run Parameter	Display	Description
MOTORS CURRENT	FAN (A) R: *.*.* S: *.*.* T: *.*.*	Electricity supply current in each of three phases to the fan motor.
VF PARAMETER	FREQ: *.*.*Hz VOLTAGE: *.*.*V CURRENT: *.*.*A POWER: *.*.*KW	Electricity supply frequency, voltage, current and power to the main motor from the VSD.

Run Parameter	Display	Description
TOTAL RUN TIME	TOTAL RUN TIME: *****H**M LOADING TIME: *****H**M	The total accumulated running time of the compressor and also the total accumulated time that the compressor has been running in loading mode.
THIS RUN TIME	THIS RUN TIME: *****H**M THIS LOAD TIME: *****H**M	The total time that the compressor has been running since last being manually started by pushing the Start button. And also, the total time that the compressor has been running in loading mode since last being manually started.
MAINTENANCE SET	Initial screen display: RUN TIME (H) OIL FILTER: **** O-A FILTER: **** AIR FILTER: **** Press the ▼ button again to display additional items: LUBE: **** GREASE: ****	The total time that the compressor has been running since its last oil filter, air-oil separator and air filter replacement, respectively. The total time that the compressor has been running since its last oil change and motor bearing re-grease, respectively.
HISTORY FAULT	# [FAULT DESCRIPTION] *****H	A record of the five most recent fault alarm conditions and the running hours at which each occurred. The most recent has a “#” value of 1 and the oldest has a “#” value of 5.
PROD DATA	PRODUCTION DATE: YYYY-MM-DD	The compressor’s date of manufacture.
THIS FAULT	If the compressor is currently experiencing a fault alarm condition: [FAULT DESCRIPTION] Otherwise: NO FAULT	A description of the current fault alarm condition, if any.

Note: In the above table, the symbol “*” represents a whole number between 0 and 9.

A2.0 Customer and Factory Set Parameters

A2.1 Parameter View and Modification

The customer set parameters and factory set parameters should only be modified, if required, after the compressor has been manually stopped by pressing the Stop button.

During normal compressor operation, press the ▼ button once to display the following menu:

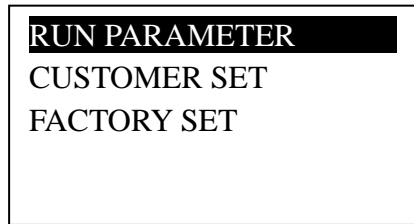

Press the ▼ button again to select "CUSTOMER SET" for access to the customer set parameters.

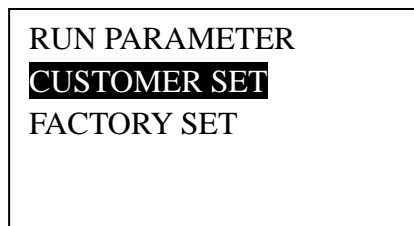

Press the ▼ button again to select "FACTORY SET" for access to the factory set parameters.

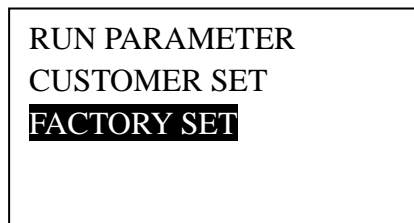

When the black cursor is on "CUSTOMER SET", press the ► button and the following customer settings sub-menu will appear:

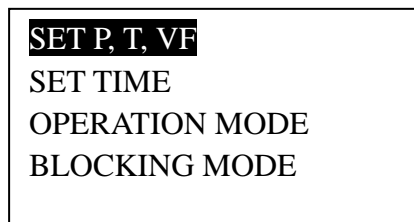

Pressing the ▼ button four times will display the second customer settings sub-menu:



When the black cursor is on "SET P, T, VF", press the ► button to display the following screen:

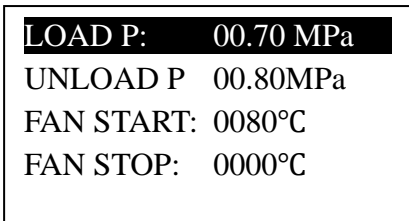

Selecting any of these parameters by using the ▼ and / or ▲ buttons and then the ► button will bring up a prompt to enter the CUSTOMER PASSWORD:



The CUSTOMER PASSWORD is 9999. Enter it using the ► button to move the blinking cursor from left to right, and use the ▼ or ▲ buttons to change the numerical value. Then press the S button and the previous screen will now reappear with the additional symbol "*" indicating that the password has been entered and the parameters can now be modified, for example:

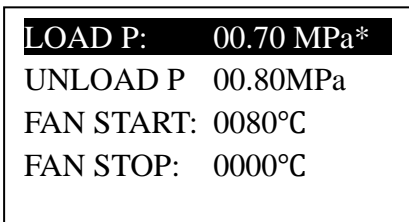

Use the ▼ or ▲ buttons to scroll through the entire list of customer set parameters. To modify any value, press the ► button and the blinking cursor will appear. Press the ► button again to move the blinking cursor from left to right, and use the ▼ or ▲ buttons to change the numerical value. Press the S button to confirm the change and the blinking cursor will disappear or press the C button to cancel the change.

Upon completion of review and / or changes to the customer set parameters, press the C button to return to the previous menu.

A2.2 Customer Set Parameters

The customer set parameters have been pre-programmed in accordance with the following table and should NOT be changed without reference to the manufacturer.

Menu Item	Parameter	Set Value	Function
SET P, T, VF	LOAD P	00.70 MPa or 00.90 MPa ^	The compressor will commence loading operation at or below this pressure. Use the lower value for standard 8 bar maximum pressure configuration. Use the higher value for optional 10 bar ^ configuration.
	UNLOAD P	00.80 MPa or 01.00 MPa ^	The compressor will commence unloading operation at or above this pressure. Use the lower value for standard 8 bar maximum pressure configuration. Use the higher value for optional 10 bar ^ configuration.
	FAN START	0080 °C	The cooling fan will start at or above this air end discharge temperature.
	FAN STOP	0000 °C	The cooling fan will stop at or below this air end discharge temperature.
	VSD PRES	00.75 MPa or 00.95 MPa ^	The compressor will automatically adjust the air end speed to maintain this pressure set point. This value cannot be set outside the range between the load and unload pressures. The lower the VSD pressure set point, the less energy is consumed by the unit.
	POWER	007.5 KW [ESV7] 011.0 KW [ESV11] 015.0 KW [ESV15]	The rated power output of the main motor. Use the specified value according to the compressor model.
	RPM (50HZ)	2900 RPM [ESV7] 2930 RPM [ESV11] 2930 RPM [ESV15]	The rated full-load speed of the main motor. Use the specified value according to the compressor model.

Menu Item	Parameter	Set Value	Function
SET TIME	FAN DELAY	0010 S	When using the controller to protect the fan motor against overload, the time value specified here must be long enough to avoid the motor in-rush current at startup.
	LOAD DELAY	0004 S	The loading delay time after the main motor starts running.
	U.L. DELAY	0300 S	The maximum continuous time that the compressor can operate in unloading mode before automatically shutting down and entering standby mode.
	STOP DELAY	0030 S	After pressing the Stop button, the compressor will operate in unloading mode for this time before shutting down.
	START DELAY	0060 S	The compressor cannot be re-started before this time has elapsed after being either manually or automatically shut down.
	VSD UP SPEED	0625	0625 is equivalent to 20 mA. This setting is to keep the PID increase under 20 mA (i.e. limit the acceleration).
	VSD DN SPEED	0625	0625 is equivalent to 20 mA. This setting is to keep the PID decrease under 20 mA (i.e. limit the deceleration).
OPERATION MODE	ON-OFF MODE	NEAR or FAR	Use “NEAR” for standalone operation via the controller’s push buttons or use “FAR” to enable the remote start / stop and sequential control features.
	LOAD MODE	AUTO	Use only the specified set value.
	COM MODE	BAN or BLOCK	Use “BAN” for standalone operation or “BLOCK” for interconnected sequential control.
	COM ADD	0001 or 0002 ~ 0016	0001: Standalone compressor or master compressor in an interconnected group. 0002 ~ 0016: Slave compressor in an interconnected group. Note that each slave unit must be assigned a unique COM ADDRESS in ascending numerical order.

Menu Item	Parameter	Set Value	Function
BLOCKING MODE	BLK STATE	MAIN or SLAVE	Use “MAIN” for standalone compressor or master compressor in an interconnected group. Use “SLAVE” for each dependent compressor in an interconnected group.
	NET	VF-IF or VF-VF	Use “VF-IF” for standalone compressor or interconnected group including at least one fixed speed compressor. Use “VF-VF” for interconnected group of variable speed compressors only.
	TURN TIME	0000 H or 0010 H	Set to “0000” for standalone compressor or “0010” for interconnected compressor to define the run-time polling interval.
	BLOCK NUMBER	0001 or 0002 ~ 0016	Set to “0001” for standalone compressor or between “0002” and “0016” to specify the total number of interconnected compressors.
	BLK MIN	00.72 MPa or 00.92 MPa ^	The lead compressor in an interconnected group will commence loading operation at or below this pressure. Use the lower value for standard 8 bar maximum pressure configuration. Use the higher value for optional 10 bar ^ maximum pressure configuration.
	BLK MAX	00.78 MPa or 00.98 MPa ^	The lag compressor will commence unloading operation at or above this pressure. Use the lower value for standard 8 bar maximum pressure configuration. Use the higher value for optional 10 bar ^ maximum pressure configuration.
	BLK DELAY	0030 S	The time delay between successive commands from the master controller to compressors in an interconnected group.
CLR LIFE TIME	OIL FILTER	0000 H	Reset to zero hours ONLY when the oil filter is replaced.
	O-A FILTER	0000 H	Reset to zero hours ONLY when the air-oil separator is replaced.
	AIR FILTER	0000 H	Reset to zero hours ONLY when the air filter is replaced.

Menu Item	Parameter	Set Value	Function
	LUBE	0000 H	Reset to zero hours ONLY when the lubricating oil is changed.
	GREASE	0000 H	Reset to zero hours ONLY when the motor is re-greased.
MAX LIFE TIME	OIL	1000 H	Oil filter replacement interval.
	O-A	2000 H	Air-oil separator replacement interval.
	AIR	2000 H	Air filter replacement interval.
	LUBE	2000 H	Lubricating oil change interval.
	GREASE	0000 H or 2000 H	Motor re-grease interval. Set to “0” for Model ESV7 or “2000” for Models ESV11 and ESV15.
LANG. SELECT	CH / EN	EN	Set this value to the required display language.
NEW USER PIN	****	9999	Use only the specified set value for access to the customer set parameters.

Note: In the above table, the symbol “*” represents a whole number between 0 and 9.

^ DO NOT enter the 10 bar maximum pressure parameters without also changing the compressor’s air end speed by replacing certain V-belt drive components otherwise the unit will be damaged. Refer to the manufacturer for instructions.

A2.3 Factory Set Parameters

The factory set parameters can only be accessed for review and / or change by using the FACTORY PASSWORD LEVEL 1 or the FACTORY PASSWORD LEVEL 2, which are made available to service technicians upon request. It is unlikely that any of the factory set parameters would need to be changed during the life of the air compressor set after dispatch from the manufacturer.

The **Level 1** factory set parameters have been pre-programmed in accordance with the table shown below.

Note that certain parameters prefixed “#” can only be accessed with the SUPER PASSWORD, which is only available for use by the manufacturer.

Parameter	Set Value	Function
FAN RATED	000.5 A	After the starting delay time, when the fan motor current is greater than 1.2 times the set value and less than 4 times the set value, the compressor will shut down per the overload alarm feature.

Parameter	Set Value	Function
PRE-ALM T	0105 °C	A pre-alarm warning will be activated if the air end discharge temperature reaches the set value.
STOP T	0110 °C	A shutdown alarm will be activated if the air end discharge temperature reaches the set value.
STOP P	00.85 MPa or 01.05 MPa ^	A shutdown alarm will be activated if the air receiver pressure reaches the set value. Use the higher value for optional 10 bar maximum pressure configuration. ^
MAX U.L.	00.80 MPa or 01.00 MPa ^	The UNLOAD P set by the user cannot exceed this value. Use the higher value for optional 10 bar maximum pressure configuration. ^
# LOAD TIME	*****H	The total cumulative loading time history. Do not change it.
# RUN TIME	*****H	The total cumulative running time history. Do not change it.
FAULT RECORD	8888	Enter the set value to clear the compressor's fault history.
VF	SELF-DEF	Use only the specified set value.
MFG	YYYY-MM-DD	The manufacturer inputs the production date of the compressor. Do not change it.
INT SCAL	00.20 MPa	Use only the specified set value.
INT. VALUE	0020	Use only the specified set value.
PORT GAIN	0100	Use only the specified set value.
INT. GAIN	0075	Use only the specified set value.
DIFF GAIN	0035	Use only the specified set value.
MAX FREQ	050.0 Hz	Maximum electricity supply frequency to the main motor from the VSD in loading mode. Do not change it.
U.L. FREQ	020.0 Hz	Minimum electricity supply frequency to the main motor from the VSD in unloading mode. Do not change it.
MIN FREQ	020.0 Hz	Minimum electricity supply frequency to the main motor from the VSD in loading mode. Do not change it.
COM SET PRA	OFF	Use only the specified set value.
# POWER FREQ	50 HZ	The frequency of the mains electricity supply to the compressor. Do not change it.
# MAX TIME	0000 H	A shutdown alarm will be activated if the total accumulated run time exceeds this value. Set at "0000" to disable this function.

Parameter	Set Value	Function
ALM STOP	0000 H	A shutdown alarm will be activated if a pre-alarm maintenance warning is not reset within this number of running hours. Set the value to “0000” to disable this function.
# PHASE PRO	ON	Enables or disables the electrical phase sequence (rotation) shutdown alarm. It must always be enabled to protect against counter-rotation of the air end. Do not change it.
STOP MODE	FREE-S	In FREE-S mode, during the DELAY STOP period the main motor speed reduces to the minimum value as governed by the U.L. FREQ setting. In the alternative SLOW-D mode, during the DELAY STOP period the main motor stops rotating immediately. Set the value to “FREE-S”; do not change it.

Note: In the above table, the symbol “*” represents a whole number between 0 and 9.

^ DO NOT enter the 10 bar maximum pressure parameters without also changing the compressor’s air end speed by replacing certain V-belt drive components otherwise the unit will be damaged. Refer to the manufacturer for instructions.

The **Level 2** factory set parameters have been pre-programmed in accordance with the table shown below. Use only the specified set values and do not change them.

Parameter	Set Value
V ADD	2106
I ADD	2104
F ADD	2103
P ADD	210F
$V=REC \times **** \div ****$	$V=REC \times 0001 \div 0001$
$I=REC \times **** \div ****$	$I=REC \times 0001 \div 0010$
$F=REC \times **** \div ****$	$F=REC \times 0001 \div 0010$
$P=R \times * \times **** \div ****$	$P=R \times 1 \times 0001 \div 0001$
C-FORM	8N1-NONE
VSD ADD	0001

Note: In the above table, the symbol “*” represents a whole number between 0 and 9.

A3.0 Alarms and Messages

A3.1 Pre-Alarm Warnings

The controller will intermittently display a pre-alarm warning together with a continuous audible beep and flashing ALARM indicator light when certain parameter limits are exceeded. Two examples are shown below:

```
PRE-A: T HIGH
          107°C
SET      105°C
```

```
PRE-A: OIL LIFE
          END
RUN TIME: 1005H
SET TIME: 1000H
```

Although the compressor will continue to operate whilst signalling a pre-alarm warning, the suspect condition should be promptly investigated and rectified to avoid the inconvenience of an alarm shutdown and possible damage to the unit.

A3.2 Shutdown Fault Alarms

In the event of a fault being detected in one or more of the monitored operating parameters, the compressor will shut down automatically. An audible alarm will beep continuously and the ALARM indicator light will be illuminated. The controller status display will indicate “FAIL TO STOP”, for example:

```
T: 85°C          0.0Hz
P: 0.75MPa      RPM
FAIL TO STOP ****S
0.0V          0.0KW
```

To investigate the fault, follow the run parameter review procedure described in Section A1.3 to display the THIS FAULT parameter. Then refer to the table shown below for a guide to interpreting the fault message and remedying the problem.

Fault Message	Fault	Likely Cause	Remedial Action
P HIGH	Over pressure.	The air receiver pressure is too high, the pressure sensor is faulty or the controller parameter settings are wrong.	Check the air receiver pressure, the pressure sensor and the controller parameters.
P SENSOR FAULT	Pressure sensor failure.	The pressure sensor is faulty or its wiring is disconnected or reversed.	Check the pressure sensor and its wiring.
T HIGH	Air end discharge temperature too high.	Poor ventilation, low oil level, wrong controller parameter settings or faulty thermostatic valve.	Check ventilation conditions, oil cooler external cleanliness, oil level, controller parameters and thermostatic valve operation.
T SENSOR FAULT	Temperature sensor failure.	The temperature sensor is faulty or its wiring is disconnected or faulty.	Check the temperature sensor and its wiring.
PHASE INVERT	Wrong phase sequence of electricity supply.	Reversed phase sequence or phase(s) off.	Check the electricity supply on all three phases and reverse the phase sequence rotation if necessary.
FAN OVERLOAD	Fan motor current overload.	Low electricity supply voltage, airflow restriction, fan blade interference, wrong controller parameter settings or faulty fan motor.	Check the electricity supply on all three phases, airflow path, fan blade clearance, controller parameters and fan motor operation.
USER MISTAKE	MAX TIME value reached.	The total accumulated run time has exceeded the MAX TIME setting.	Set the MAX TIME parameter at "0000" to disable this function.
ALM LONG	ALM STOP value reached.	The run time since pre-alarm maintenance warning has exceeded the ALM STOP setting.	Carry out any required maintenance and then set the ALM STOP parameter at "0000" to disable this function.

Fault Message	Fault	Likely Cause	Remedial Action
VSD FAILURE	VSD failure.	VSD alarm or fault, wrong controller parameter settings, wiring is disconnected or faulty, or wrong VSD parameter settings.	Switch off the mains electricity supply for one minute to reset the VSD and then re-start the compressor, repeat three times if necessary; check controller parameters; check the electricity supply on all three phases; check the electrical power and control wiring; check the VSD parameters and any fault messages on the VSD control panel.

Appendix B C2000 Variable Speed Drive

B1.0 General Description

B1.1 Introduction

The compressor is equipped with a Delta Electronics C2000 Series Variable Speed Drive (VSD). The VSD uses sophisticated control technology to vary the compressor drive motor's speed in response to fluctuating compressed air demand.



Figure B-1 Delta C2000 Series Variable Speed Drives

In simple terms, the VSD is connected to the mains alternating current (AC) electrical power supply that has both constant voltage and frequency, e.g. 415 Volts and 50 Hertz. The VSD firstly converts the input AC power into direct current (DC) power. It then inverts this DC power back to AC power, but with variable voltage and frequency to control the speed of the compressor's AC drive motor as instructed by the MAM-660 Controller.

B1.2 Special Precautions

The VSD is located inside the compressor's electrical cabinet where there is a danger of high voltage. The electrical cabinet should only be opened by a licensed electrician. There are no user adjustable controls on the VSD.

It is recommended that inspection and cleaning of the VSD's external and internal components be carried out at no less than yearly intervals.

There are highly sensitive metal oxide semiconductor ("MOS") components on the printed circuit boards. These components are especially sensitive to static electricity. Do not touch these components or the circuit boards without taking anti-static precautions. Never reassemble internal components or wiring. Remove any personal metal objects such as watches and rings

before carrying out any maintenance on the VSD and use only insulated tools.

Ensure that the compressor and the VSD are electrically earthed. The VSD is equipped with an earth terminal for this purpose. Do not connect the VSD output terminals U/T1, V/T2 and W/T3 directly to the mains power supply.

The compressor should not be installed in an environment where it's exposed to chemicals, dust, dirt, fibres, moisture, oil, salt or flammable / explosive liquids or gases. These pollutants may damage the electronic and high voltage components within the VSD and cause it to burn out or explode.

If the VSD is stored without use for more than three months, the ambient temperature should not be higher than 30°C. Storage longer than one year is not recommended as it could result in degradation of the electrolytic capacitors.







B1.3 Keypad

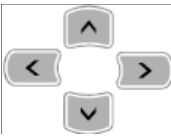







Figure B-2 Keypad and Display

The VSD's keypad and display is shown in Figure B-2. The functionality of the keys and the three main LED indicators is described in Table B-1 below.

Table B-1 Keypad and LED Functions

Key or LED	Description
	<p>RUN Command Key:</p> <p>This key is normally disabled when the VSD is in automatic “AUTO” mode. When in manual “HAND” mode under special circumstances, for example such as fault finding, press this key to start the compressor drive motor. Otherwise, do not operate the compressor in HAND mode or press the RUN key.</p>
	<p>STOP / RESET Command Key:</p> <p>This key is normally disabled when the VSD is in automatic AUTO mode. When in manual HAND mode under special circumstances, press this key to stop the compressor drive motor. Otherwise, do not operate the compressor in HAND mode.</p> <p>A VSD fault alarm can be reset by pressing the STOP / RESET key. Alternatively, an alarm can also be reset by switching off the mains electricity supply to the unit for one minute.</p>
	<p>FWD / REV Command Key:</p> <p>This key is normally disabled. Do not press it.</p>
	<p>ENTER Key:</p> <p>Press ENTER to go to the next menu level. If already at the last level, press ENTER to execute the command.</p>
	<p>ESC Key:</p> <p>Press ESC to leave the current menu and return to the previous menu. It also functions as a return key in the sub-menu.</p>
	<p>MENU Key:</p> <p>Press MENU to go to the main menu selection as follows:</p> <ol style="list-style-type: none"> 1. Parameter Setup 2. Copy Parameter 3. Keypad Lock 4. PLC 5. Copy PLC 6. Fault Record 7. Quick Start 8. Display Setup 9. Time Setup 10. Language 11. Start-Up 12. Main Page 13. PC Link

Key or LED	Description
	<p>LEFT / RIGHT / UP / DOWN Keys:</p> <p>In the numeric value setting mode, use these keys to move the cursor and change the numeric value. In the menu / text selection mode, use these keys for item selection.</p>
	<p>Function Keys:</p> <p>These keys are normally disabled when the VSD is in automatic AUTO mode. When in manual HAND mode under special circumstances, press F1 to joggle or “bump test” the compressor drive motor. Otherwise, do not operate the compressor in HAND mode or press the Function keys.</p>
	<p>HAND Mode Key:</p> <p>This key is normally disabled when the compressor is running. When stopped, the VSD can be switched from automatic AUTO mode to manual HAND mode by pressing this button; this should only be done in special circumstances. Otherwise, do not operate the compressor in HAND mode or press the HAND key.</p>
	<p>AUTO Mode Key:</p> <p>This key is normally disabled when the compressor is running. If the VSD has been switched to manual HAND mode, press this key to switch back to automatic AUTO mode. Otherwise, do not operate the compressor in HAND mode or press the AUTO key.</p>
	<p>RUN LED:</p> <p>Green Light On: The VSD is running the compressor drive motor. Green Light Flashing: The VSD is decelerating the motor to a stop. Light Off: The motor is stopped.</p>
	<p>STOP LED:</p> <p>Red Light On: The VSD has stopped the compressor drive motor. Red Light Flashing: The VSD is in standby mode. Light Off: The VSD is running the motor.</p>
	<p>FWD / REV LED:</p> <p>Green Light On: The VSD is or will be running the compressor drive motor in the normal forward direction of rotation. Red Light On: The VSD is or will be running the motor in the incorrect reverse direction of rotation. This should never occur. It will permanently damage the air end. Light Flashing: The VSD is changing the direction of motor rotation. This should never occur. If the motor runs in reverse, it will permanently damage the air end.</p>

B1.4 Display

During normal operation in automatic AUTO mode, the display will generally appear as shown in Figure B-3. Note that “AUTO” is displayed at the top right-hand corner of the screen.

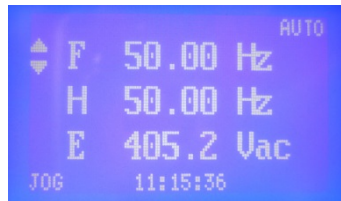

Figure B-3 VSD Display in AUTO Mode

The “F” value is the frequency command from the MAM-660 controller to the VSD for operation of the compressor drive motor.

The “H” value is the frequency of the power supply from the VSD to the motor.

The “E” value is the voltage of the power supply from the VSD to the motor.

Pressing the UP or DOWN direction keys will enable the value for “A” to be displayed, which is the current of the power supply from the VSD to the motor.

If the VSD is ever operated in manual HAND mode, this status is indicated by “HAND” being displayed at the top right-hand corner of the screen as shown in Figure B-4.



Figure B-4 VSD Display in HAND Mode

The compressor set will not function properly if the VSD is switched to manual HAND mode; it should normally always be left in automatic AUTO mode.

B2.0 Parameter Setup and Operating Faults

B2.1 Setting the Language

The VSD display language is selectable at Item 10 on the main menu. It is preset by the manufacturer as English and should not normally require changing. Press the MENU key first and then use the direction and ENTER keys to select the desired language. When finished, press the ESC key twice to return to the VSD status display screen.

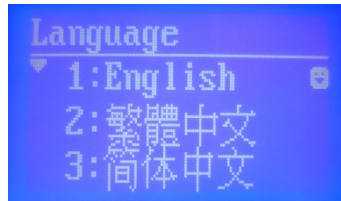

Figure B-5 Language Selection Screen

B2.2 Setting the Time and Date

The VSD time and date can be set at Item 9 on the main menu; these are preset by the manufacturer to Australian Eastern Standard Time (AEST). Press the MENU key first and then use the direction and ENTER keys to set the desired time and date. Note that the VSD does not have automatic daylight saving time functionality. When finished, press the ESC key twice to return to the VSD status display screen.

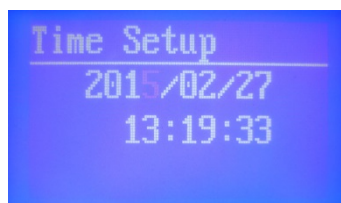

Figure B-6 Time and Date Setting Screen

B2.3 Reviewing and Setting the Operating Parameters

The VSD operating parameters are preset by the manufacturer and should not normally require reviewing or changing. Any necessary adjustments to the compressor's operating parameters such as load and unload pressures, maintenance times and so on need only be entered into the MAM-660 Controller.

It is necessary to enter the VSD PARAMETER PROTECTION PASSWORD **before** reviewing and / or setting any of the operating parameters. This password is made available to service technicians upon request.

To review and / or set any of the VSD operating parameters:

- (a) Press the MENU key.
- (b) Use the direction and ENTER keys to:
 - i. Select Item 1 “Pr Setup” on the main menu.
 - ii. Select Item 00 “System Parameters” on the parameter setup menu.
 - iii. Select Item 07 “Password Decoder” on the next sub-menu.
 - iv. Enter the VSD PARAMETER PROTECTION PASSWORD.
- (c) The VSD parameters can now be reviewed and / or set as required.
- (d) When finished, use the ESC key to return to the VSD status display screen.

There are more than 600 operating parameters in the VSD’s complete setup, however only the 20 or so parameters listed in Table B-2 below need to be specifically entered; all of the other parameters remain unchanged from the VSD’s default settings.

Table B-2 Non-Default VSD Operating Parameter Settings

Parameter Setup Menu Item	Parameter Setup Submenu Item	Parameter Description	Set Value
00	04	Content of Multi-Function Display	4
00	20	Source of Master Frequency Command (AUTO)	2
00	21	Source of the Operation Command (AUTO)	1
00	23	Control of Motor Direction	1
01	00	Maximum Operation Frequency	50.00
01	01	Output Frequency of Motor 1	50.00
01	02	Output Voltage of Motor 1	415.0
01	03	Mid-Point Frequency 1 of Motor 1	20.00
01	04	Mid-Point Voltage 1 of Motor 1	200.0
01	06	Mid-Point Voltage 2 of Motor 1	5.0
01	09	Start-Up Frequency	0.50
01	10	Output Frequency Upper Limit	50.00
01	11	Output Frequency Lower Limit	20.00
01	12	Accel. Time 1	10.00

Parameter Setup Menu Item	Parameter Setup Submenu Item	Parameter Description	Set Value
01	13	Decel. Time 1	05.00
03	00	Analog Input Selection (AVI)	0
03	01	Analog Input Selection (ACI)	1
05	01	Full Load Current of Induction Motor 1 (A)	16.32 [ESV7] 23.40 [ESV11] 31.44 [ESV15]
05	02	Rated Power of Induction Motor 1 (kW)	7.50 [ESV7] 11.00 [ESV11] 15.00 [ESV15]
05	03	Rated Speed of Induction Motor 1 (rpm)	2900 [ESV7] 2930 [ESV11] 2930 [ESV15]
05	04	Pole Number of Induction Motor 1	2
06	13	Electronic Thermal Relay Selection (Motor 1)	0
06	14	Electronic Thermal Characteristic for Motor 1	120.0
07	19	Fan Cooling Control	1
09	04	COM1 Communication Protocol	12

B2.4 Re-setting and Re-entering the Operating Parameters

A situation may arise whereby there's doubt about whether some of the VSD's other parameters have been changed from the default settings. Or, perhaps, there may be a requirement to program a replacement VSD unit. In such cases, all of the VSD's operating parameters should be reset to the factory default settings and then only those listed in Table B-2 above should be changed to the specified values.

After resetting the VSD's operating parameters to the factory default settings, the compressor will not function properly and will likely be permanently damaged if the VSD operating parameters listed in Table B-2 are not set to the specified values.

To reset the VSD's operating parameters to the factory default settings and then re-enter the mandatory non-default settings:

- (a) Press the MENU key.
- (b) Use the direction and ENTER keys to:
 - i. Select Item 1 "Pr Setup" on the main menu.
 - ii. Select Item 00 "System Parameters" on the parameter setup menu.
 - iii. Select Item 07 "Password Decoder" on the next sub-menu.
 - iv. Enter the VSD PARAMETER PROTECTION PASSWORD.
 - v. Select Item 1 "Pr Setup" on the main menu.
 - vi. Select Item 00 "System Parameters" on the parameter setup menu.
 - vii. Select Item 02 "Parameter Reset" on the next sub-menu.
 - viii. Enter the value "9" to reset all of the parameters to the factory default 50 Hz settings. The VSD's internal cooling fan will now switch on continuously.
 - ix. Repeat Step (i) to Step (iv) above.
 - x. Select each of the operating parameters listed in Table B-2 and set it to the specified value. Do this carefully one parameter at a time from top to bottom without omitting any. After setting Parameter Item 07-19, the VSD's internal cooling fan will switch off unless its internal temperature is greater than 60°C.
 - xi. Repeat Step (x) to double-check that each of the non-default parameters has been correctly set.
- (c) The VSD parameters have now been reset to the factory default values and the mandatory non-default values have also been subsequently entered.
- (d) When finished, use the ESC key to return to the VSD status display screen.

B2.5 VSD Faults

In the event of a fault being detected in the VSD, the compressor will shut down automatically and annunciate a "VSD FAILURE" on the MAM-660 Controller display. The most likely cause of the reported fault is:

- (a) Wrong controller parameter setting(s);
- (b) Wiring disconnection or fault;
- (c) Electrical power supply fault;
- (d) Wrong VSD parameter setting(s); or
- (e) VSD fault.

The recommended course of action to rectify the problem is as follows:

- (a) Switch off the mains electricity supply for one minute to reset the VSD and then re-start the compressor, repeating three times if necessary;
- (b) Check that all of the controller parameters have been correctly set;
- (c) Check the electricity supply on all three phases;
- (d) Check the electrical power and control wiring;
- (e) Check that all of the VSD parameters have been correctly set; and
- (f) If necessary, re-set and re-enter the VSD parameters as described in Section B2.4 above.

If the fault is remedied in between Steps (b) and (f), inclusive, it'll still be necessary to reset the VSD as described in Step (a) or by pressing the STOP / RESET key on the VSD before the compressor can be re-started.

In a situation where the above recommended solutions don't fix the problem, a licensed electrician will need to access the VSD within the compressor's electrical cabinet to read whatever fault message(s) may be displayed on its keypad screen while the unit is electrically energised. Refer to the manufacturer for instructions.

Appendix C Remote Start and Stop Control

C1.0 Safety

The compressor has a built-in feature that allows it to be started and stopped by remote hard-wired control supplied and installed by others. However, this feature does not include provision for remote monitoring of the compressor's status or any local alarm / annunciation that the unit is about to start or stop. The remote start and stop feature should therefore NOT be used unless the person conducting a business or undertaking involving the management or control of the plant has first implemented the following risk control recommendations especially:

- (a) Do not operate the compressor with any of its maintenance access panels open or removed.
- (b) Before opening or removing any of its maintenance access panels and / or performing any maintenance work on the compressor or connected pneumatic system: switch off the unit; isolate and tag-out the power supply; carefully release any residual air pressure from the internal air-oil receiver tank, compressed air receiver tank and any connected piping; and close the air outlet valve.

C2.0 Installation

All electrical installation, maintenance or repair work should be performed by a licensed electrician.

- (a) Make the compressor safe for maintenance work in accordance with Section C1.0 (b)
- (b) Locate terminals 6, 8 and 19 on the rear of the MAM-660 Controller as shown below.

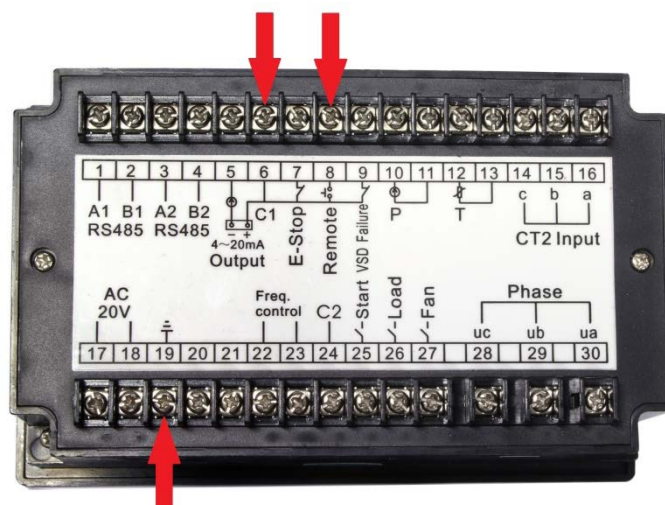



Figure C-1 Rear View of MAM-660 Controller

- (c) Connect a normally open, non-latching, single pole, push button switch (i.e. the remote control switch) between terminals 6 and 8 using a single twisted-pair, screened data or instrumentation cable. Connect one end only of the screen to earthing terminal 19. The circuit voltage and current are 25 V DC and 20 mA, respectively.
- (d) Reinstall any components that were removed in Step (b) to give access to the rear of the controller.
- (e) Prepare the compressor for use in accordance with Section 5.0.
- (f) Follow the procedure described in Section A2.0 to change the ON-OFF MODE customer set parameter in the controller to the “FAR” set value.

The compressor is now ready for operation by local command via the MAM-660 Controller or by remote control via the push button switch.

C3.0 Operation

Pressing and holding the remote control switch for two seconds has the same functionality as pressing either the controller’s Start button  (if the unit is shut down) or Stop button  (if the unit is running). The remote control switch must be released (i.e. opened) and then pushed (i.e. closed) again for two seconds in order to cycle the unit to the next start or stop command.

The functionality of the push buttons on the MAM-660 Controller remains unchanged when the remote control feature is enabled.

Appendix D Sequential Control

D1.0 Safety

The compressor has a built-in feature that allows it to be interconnected with up to 15 other Senator ES and / or ESV compressors for operation as a group by sequential control to save energy. All of the compressors within the group should ideally be of the same size. The control signals are communicated by a hard-wired connection that is supplied and installed by others.

The sequencing feature does not include provision for remote monitoring of any compressor’s status or any local alarm / annunciation that a unit is about to start or stop. The sequencing feature should therefore NOT be used unless the person conducting a business or undertaking involving the management or control of the plant has first implemented the following risk control recommendations especially:

- (a) Do not operate any compressor with its maintenance access panels open or removed.
- (b) Before opening or removing any of its maintenance access panels and / or performing any maintenance work on the compressor or connected pneumatic system: switch off the unit; isolate and tag-out the power supply; carefully release any residual air pressure from the internal air-oil receiver tank, compressed air receiver tank and any connected piping; and close the air outlet valve.

D2.0 Installation

All electrical installation, maintenance or repair work should be performed by a licensed electrician.

- (a) Make each compressor in the group safe for maintenance work in accordance with Section D1.0 (b)
- (b) Locate terminals 1, 2 and 19 on the rear of each MAM-660 Controller. Also, locate terminals 6, 7 and 8 on each MAM-870 Controller, if any. Refer to Figure D-1.

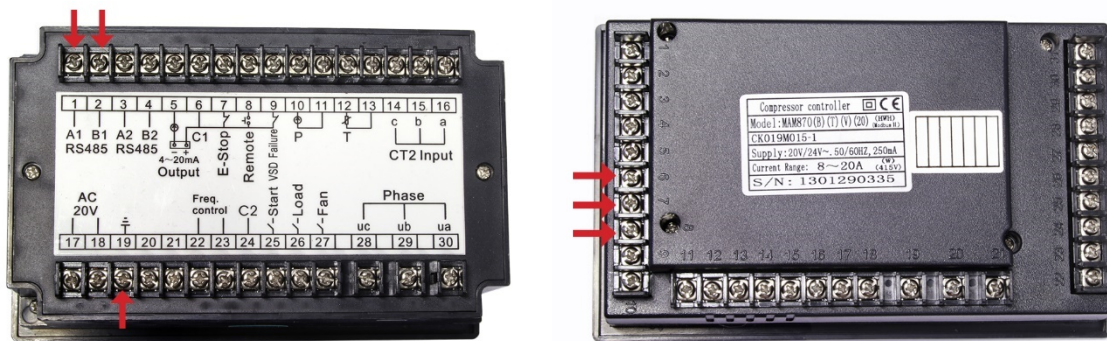



Figure D-1 Rear View of MAM-660 (Left) and MAM-870 (Right) Controllers



- (c) Connect all of the MAM-660 #1 terminals and all of the MAM-870 #6 terminals together in a daisy chain using one core of a single twisted-pair, screened data or instrumentation cable. Connect all of the MAM-660 #2 terminals and all of the MAM-870 #7 terminals together in a daisy chain using the other core. Connect one end only of the screen in each cable segment to either earthing terminal 19 (MAM-660) or earthing terminal 8 (MAM-870).
- (d) Reinstall any components that were removed in Step (b) to give access to the rear of the controllers and then prepare the compressors for use in accordance with Section 5.0.
- (e) Follow the procedures described in Appendix A for setting the controller parameters on each compressor to the correct values for interconnected sequencing operation.

D3.0 Operation

In an interconnected uniform group of all fixed speed or all variable speed compressors, assignment of the “lead” unit – i.e. the compressor which loads first and unloads last – is given to that machine with the lowest accumulated runtime at the TURN TIME or TOGGLES TIME interval defined in Appendix A.

In an interconnected mixed group of fixed and variable speed compressors, if a variable speed unit is set as the MAIN or MASTER (with a COM ADDRESS of 0001) then it will always be the lead machine. Or alternatively if a fixed speed unit is set as the MAIN or MASTER, assignment of the lead unit will be made automatically according to the lowest accumulated runtime. Setting the variable speed compressor as the master unit in such mixed groups is generally the most energy efficient solution.

To start all of the compressors in an interconnected group, press the Start button  on the master compressor only. The slave compressors will start automatically in sequence as required. Pressing the Start button  on any slave compressor starts that particular unit only with standalone functionality (i.e. not sequencing control).

To stop all of the compressors in an interconnected group, press the Stop button  on each and every compressor. Pressing the Stop button  on the master compressor stops that particular unit only and temporarily disables the sequencing control function; the other compressors in the group will continue to operate as standalone units.

The controller parameters specified in Appendix A for sequencing operation are nominal settings that are generally suitable for most applications. If, however, your interconnected group of compressors does not operate optimally – for example with periods of insufficient system pressure or excessive load / unload cycling (> 120 cycles/hour) – please contact your Senator dealer or Glenco Air & Power for specific advice.



Glenco Air & Power Pty Ltd ABN 21101370085 | **address** 21 Resource Street, Parkinson QLD 4115, Australia
phone 07 3386 9999 | **fax** 07 3386 9988 | **email** sales@glencomfg.com.au | **web** www.glencoairpower.com.au