



Instruction Manual



Senator DSV Series Air Compressor Sets with AIMS Controller V2.06

Revision: 2024-10-11



Introduction

Thank you and congratulations for purchasing a high-quality Senator air compressor set. It has been designed and manufactured to provide many years of safe and reliable service if installed, operated and maintained in accordance with these instructions.

Please read and understand this manual before operating the compressor. Failure to do so could result in death, severe injury or substantial property damage. This manual should be considered a permanent part of the compressor and should remain with it if resold.

Disclaimers

All information, illustrations and specifications in this manual are based on the latest information available at the time of publishing. The illustrations are intended as representative reference views only. Due to our policy of continuous product improvement, we may modify information, illustrations or specifications to explain or exemplify a product, service or maintenance improvement.

We reserve the right to make any change at any time without notice. Your compressor may differ slightly from models pictured, including optional accessories.

All Rights Reserved

No part of this publication may be reproduced or used in any form by any means – graphic, electronic or mechanical, including photocopying, recording, taping or information storage and retrieval systems – without the written permission of Glenco Air & Power Pty Ltd.

Contents

1.0	Safety	1
2.0	Product Description	4
3.0	Installation	18
4.0	Operation	23
5.0	Maintenance	29
6.0	Fault Diagnosis and Repair	38
7.0	Warranty	41
Appendix A	AIMS Controller V2.06	43
Appendix B	Variable Speed Drive	61
Appendix C	Remote Start and Stop Control	69

1.0 Safety

The air compressor should only be operated by authorised persons. All users should follow the instructions and safety warnings as (a) described in this instruction manual, (b) shown on any decals affixed to the unit and (c) described in the Plant Risk Assessment also available from the manufacturer.

All users of the compressor and any other workers likely to be in the vicinity thereof should undergo training to achieve the requisite minimum level of operator competence before placing the unit into service.

Installation, commissioning, maintenance, repair and end-of-life decommissioning of the unit should be performed by an authorised Senator compressor technician if possible.

The compressor should be installed in a horizontal position on a firm, level and stationary foundation such as a concrete floor that is strong enough to support its weight. The unit should not impede pedestrian or vehicular traffic.

The compressor should be installed in a well-ventilated area most preferably indoors. If it has to be located outdoors, the unit must be provided with protection from precipitation (or other liquids) and direct sunlight.

Do not locate the compressor where it may be exposed to chemicals, dust, dirt, fibres, oil, salt, water or other liquids, or flammable, explosive or otherwise hazardous liquids, gases or dusts. The area should not be wet or damp. The unit should be kept away from other heat sources.

All electrical installation, maintenance or repair work should be performed by a licensed electrician.

The electricity supply circuit to the compressor should comply with the AS/NZS 3000:2018 Wiring Rules. It should include a fixed setting residual current device (RCD) with a rated operating residual current not exceeding 30 mA. A special RCD may need to be considered for use with high current or variable speed drives to prevent nuisance tripping.

Do not use the unit to compress any gas other than air.

Compressed air can contain carbon monoxide, hydrocarbons or other poisonous contaminants that can cause death or serious injury. The compressor is not designed, intended or approved for breathing air. Do not use compressed air for breathing air applications without proper treatment.

Before operating the compressor, check the safety of any hoses, piping and pneumatic equipment connected to the discharge air outlet valve. Use only hoses, piping, fittings, air receivers, air tools, etc. connected to the compressor's discharge outlet valve that are safe for the unit's maximum discharge pressure (i.e. 800, 1,000 or 1,300 kPa depending upon configuration) and temperature (i.e. 100°C). Do not use PVC plastic piping.

The compressor should not be operated beyond its specified design parameters, especially the maximum discharge pressure.

Do not bypass or disable any of the unit's safety features, especially its pressure-relief valve.

Do not modify the compressor without written permission from the manufacturer.

Do not operate the compressor with any of its maintenance access panels open or removed. The unit may start automatically without warning.

Do not direct a compressed air discharge stream onto a person's body.

Monitor the compressor and downstream compressed air system for any excessive noise, vibration, leaks or other abnormalities and repair any faults immediately.

Before performing any maintenance work on the compressor, switch off the unit, isolate and tag-out the power supply, carefully release any residual air pressure from the internal air-oil receiver and any connected downstream piping in the user's network, and close the air outlet valve. And if possible, allow the unit to cool down if it's been running.

Before performing any maintenance work on the compressor's variable speed drive (VSD), switch off the unit, isolate and tag-out the power supply, and wait 10 minutes. Check that the VSD's capacitors have fully discharged by measuring the DC voltage between their positive and negative terminals, which should be less than 25 V DC.

During maintenance work, take care to prevent any body parts, clothing or tools from touching any hot or moving components inside the compressor cabinet.

The maintenance access panels should be handled as a two-person lift and stored laid flat in a horizontal position when removed.

Carry out preventative maintenance on the compressor in accordance with the recommended schedule using only genuine spare parts.

Clean up any oil leak discharge or oil spill immediately.

Drain condensate from the air-oil receiver only when it is depressurised. Monitor the drained condensate to check whether it poses a slip hazard, e.g. excessive condensate discharged onto a smooth, non-porous floor.

Clothing sleeves should be tight fitting, long hair should be tied back, jewellery and other loose articles should be removed, and loose gloves should not be worn when operating or maintaining the compressor.

Wear body protection such as tight-fitting gloves, long sleeves, safety boots and eye protection such as glasses when performing any maintenance work on the compressor.

Wear eye protection such as glasses if working close to pressurised compressed air plant.

Wear protection such as a filter respirator and goggles when blowing down with compressed air. Minimise the generation of dust by compressed air blowing. Never use compressed air to blow down silica dust.

Wear appropriate eye, respiratory and body protection when spraying paint or other chemicals with compressed air. Refer to the chemical's MSDS for specific personal protective equipment (PPE) recommendations.

2.0 Product Description

2.1 Overview

The DSV Series compressor sets are stationary, single-stage, oil-lubricated rotary screw type driven by a variable speed electric motor. They are enclosed within a noise attenuated cabinet.

The compressors feature an advanced microprocessor controller with LCD display that provides efficient control, monitoring and protection of the unit’s functions. The controller also serves as a convenient and intuitive interface between the operator and the compressor.

This range of compressors is available only in standalone, floor-mounted configuration. They are normally connected to downstream compressed air storage, treatment and distribution equipment to form a complete system.

2.2 Compressor Systems

The compressor consists primarily of the rotary screw air end, electric motor, air-oil receiver and separator, oil system, cooling system, air system, electrical control system and other ancillary components.

A simplified flow diagram of the unit is shown in Figure 2-1.

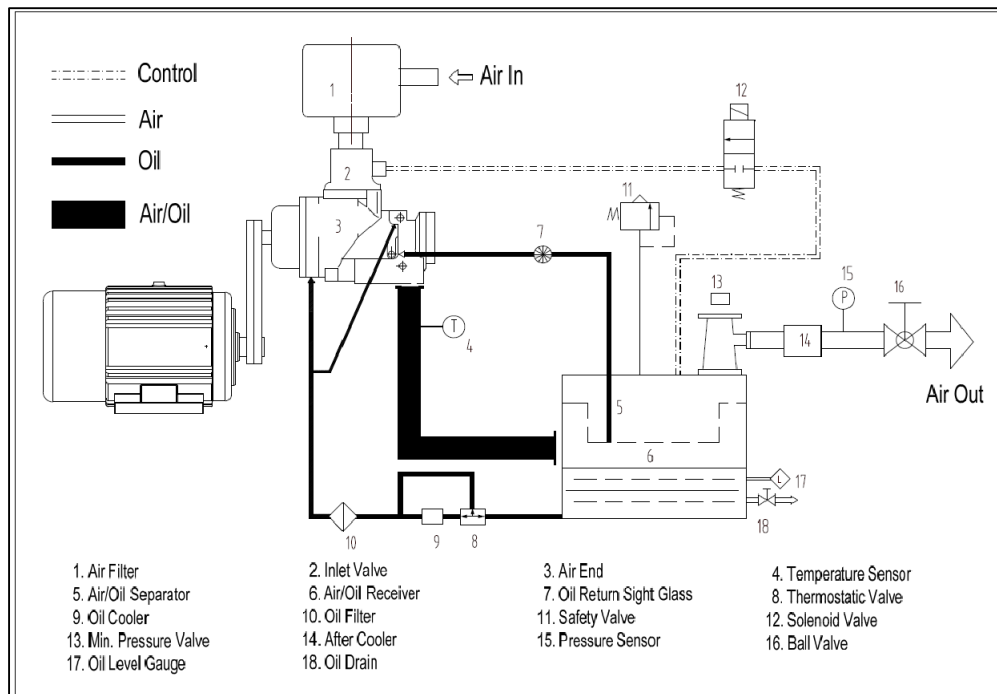

Figure 2-1: Compressor Flowchart

2.2.1 Air System

Ambient air is drawn in via the air filter and flows through the inlet valve into the rotary screw air end for compression. Oil is continuously injected into the air end to provide both lubrication and cooling. The compressed air and oil mixture flows into the air-oil receiver for preliminary separation and then into the air-oil separator. After the air and oil are separated, the compressed air flows through the minimum pressure valve, then the after-cooler and is finally discharged into the pipeline network of the user.

The function of the air filter is to remove any particulate matter such as dirt and dust to ensure that only clean air enters the compressor's screw air end. The inlet valve is kept fully open whenever the compressor is in loading mode, whereby it is pumping compressed air into the air receiver. If the discharge air pressure rises to a pre-programmed maximum, the compressor enters unloading mode whereupon the inlet valve closes fully to stop any further air being delivered into the user's network.

The electronic controller continuously monitors the discharge air pressure and varies the motor speed within a control range of ≈ 40 to 100% in order to maintain a pre-programmed target pressure. Adjusting the compressor's flowrate to match fluctuating air demand without entering inefficient unloading mode is the primary means of energy saving offered by a variable speed compressor.

The inlet valve is kept closed during compressor start-up to reduce load on the air end motor. When the unit is shut down, the inlet valve is closed to prevent compressed air and oil flowing backwards from the air-oil receiver and being ejected through the air inlet.

The minimum pressure valve ensures that the pressure in the air-oil receiver doesn't fall below ≈ 4.5 bar when the compressor is running so that the lubricating oil can flow normally in the system. When the compressor is running in unloading mode or shut down, the minimum pressure valve prevents the compressed air in the pipeline network of the user from flowing backwards into the unit.

An automatic vent valve is located beside the inlet valve. The vent valve automatically opens to release air pressure from the air-oil receiver whenever the compressor is in unloading mode or shut down.

2.2.2 Lubrication System

The compressed air and oil mixture is injected into the air-oil receiver and collides with its inner wall. Most of the lubricating oil is separated from the air-oil mixture during this process and accumulates in the lower part of the air-oil receiver. The remaining oil is captured by the air-oil separator and transferred back to the screw air end via the oil return pipe.

During compressor operation, when the temperature of the lubricating oil is below the minimum set value for the pressure configuration (refer to Specifications) the thermostatic valve automatically opens the bypass circuit and the circulating oil from the air-oil receiver is directly injected under air pressure into the screw air end and individual lubricating points via the oil system piping and oil filter. As the oil temperature rises above the minimum set value, the thermostatic valve gradually shuts off the bypass circuit and simultaneously opens the circuit

going to the oil cooler. If the oil temperature reaches the maximum set value, the bypass circuit is completely shut off and the entire lubricating oil flow from the air-oil receiver is passed through the oil cooler circuit on its way back to the air end.

The functions of the thermostatic valve are to (a) maintain constant temperature and viscosity of lubricating oil, (b) enable the system to reach the optimal operating temperature as soon as possible and (c) maintain sufficient temperature to prevent water vapour in the system from condensing. The function of the lubricating oil filter is to remove any metal wear particles and lubricating oil cracking products to minimise wear of the air end bearings and rotors.

2.2.3 Cooling System

Cooling air is drawn from outside the unit by the cooling fan and then blown across the radiator fins of the combined oil cooler and air after-cooler. Heat exchange takes place between the cooling air and the hot oil and compressed air streams to achieve a cooling effect. The maximum ambient air temperature should not exceed 45°C otherwise excessively high compressed air and oil temperatures will occur; this will shorten the life of the lubricating oil and may activate over-temperature shutdown of the compressor.

2.2.4 Control Protection System

The compressor has a microcomputer controller that automatically adjusts the operating state of the unit according to the actual air consumption of the user's application.

If the air consumption is low or the air application is paused, the air end motor speed will reduce proportionately to save energy or, if necessary, the inlet valve will close to allow the compressor to operate in unloading mode. After the air consumption is recommenced, the controller will re-open the inlet valve to enable the compressor to operate normally in loading mode and the air end motor speed will increase to match air demand. The controller always monitors the compressor when it's running. If any abnormal condition – such as motor overload or air discharge over-temperature – is detected, the controller automatically shuts down the compressor to protect it against damage.

A safety valve is installed in the air-oil receiver. If the pressure inside the receiver exceeds its design rating, the safety valve will automatically open to quickly discharge the air and reduce the pressure, thereby ensuring safety of the unit and personnel. The safety valve should not open during normal operation.

2.2.5 Electrical System

The electrical system consists primarily of the air end motor, variable speed drive (for the air end motor), fan motor (if equipped), electrical control cabinet assembly, solenoid valve, temperature sensor, pressure sensor and controller.

To protect the air end and fan motors against overheating damage due to abnormal conditions, their operating current draws are monitored by the variable speed drive and a hard-wired motor protection circuit breaker, respectively. If either motor current exceeds its allowable value, the

compressor controller will perform an immediate shutdown and an alarm message will be shown on the controller's display panel.

Please refer to the separate wiring diagram booklet(s).

2.2.6 Compressor Controller and Operation Panel

The compressor is fitted with an Air Intelligent Management System (AIMS) controller with built-in user interface. The controller handles the automatic operation, monitoring and protection of the compressor's functions.

To ensure normal and safe operation of the compressor, users should be familiar with the functions and meanings of the individual buttons and display messages on the controller. Please refer to Appendix A for the details.

2.3 Main Components

The typical structures of the DSV Series compressors are shown in Figures 2-2(a) to (c) for your familiarisation. Please note that not all components are able to be shown and that your compressor may differ from that illustrated.

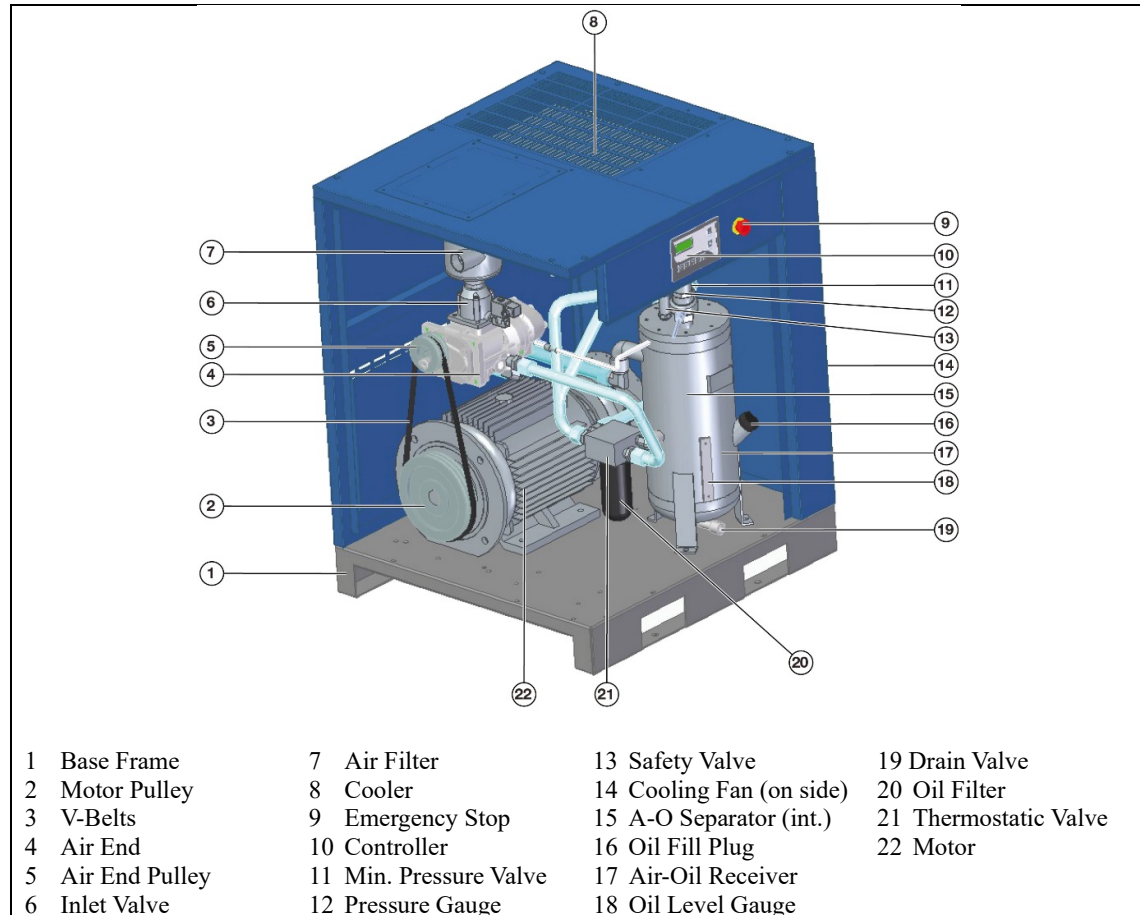

Figure 2-2(a): Structure of a DSV Series Air Compressor Set - Models DSV8 to DSV15

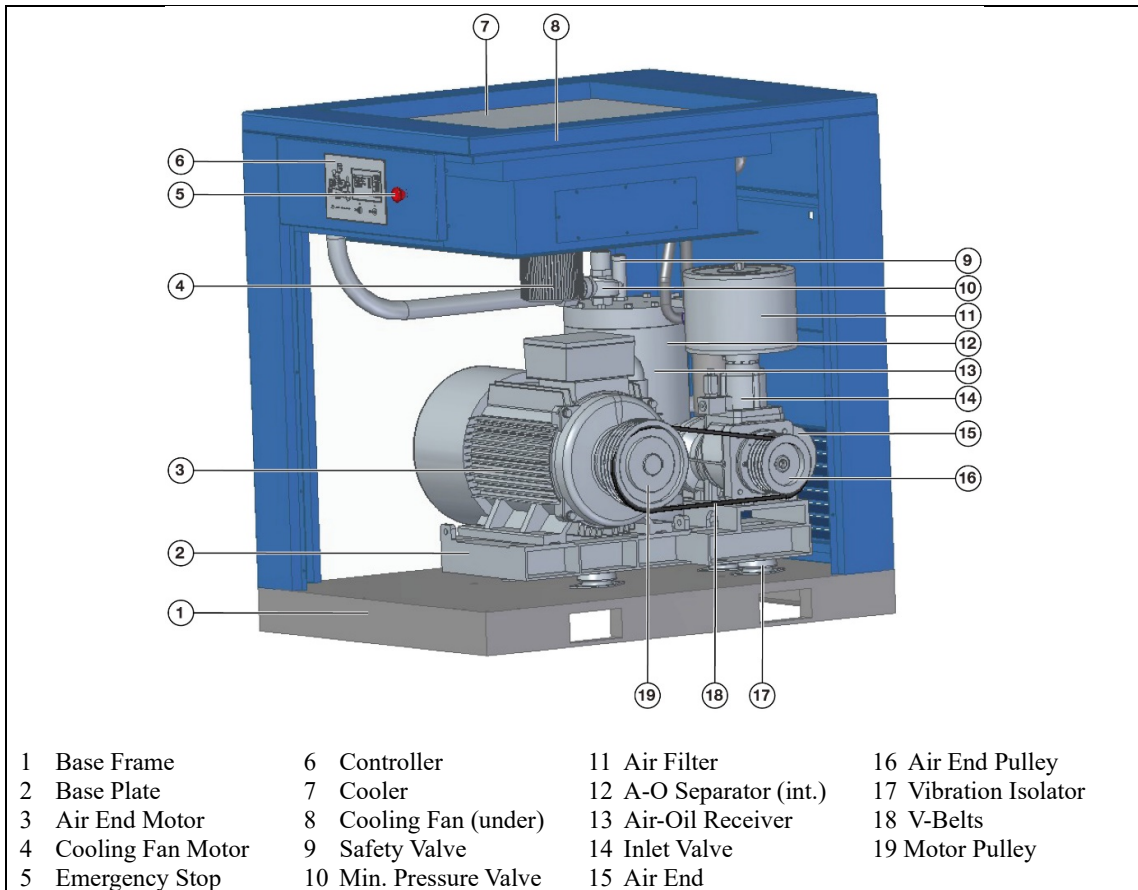

Figure 2-2(b): Structure of a DSV Series Air Compressor Set - Models DSV18 to DSV45

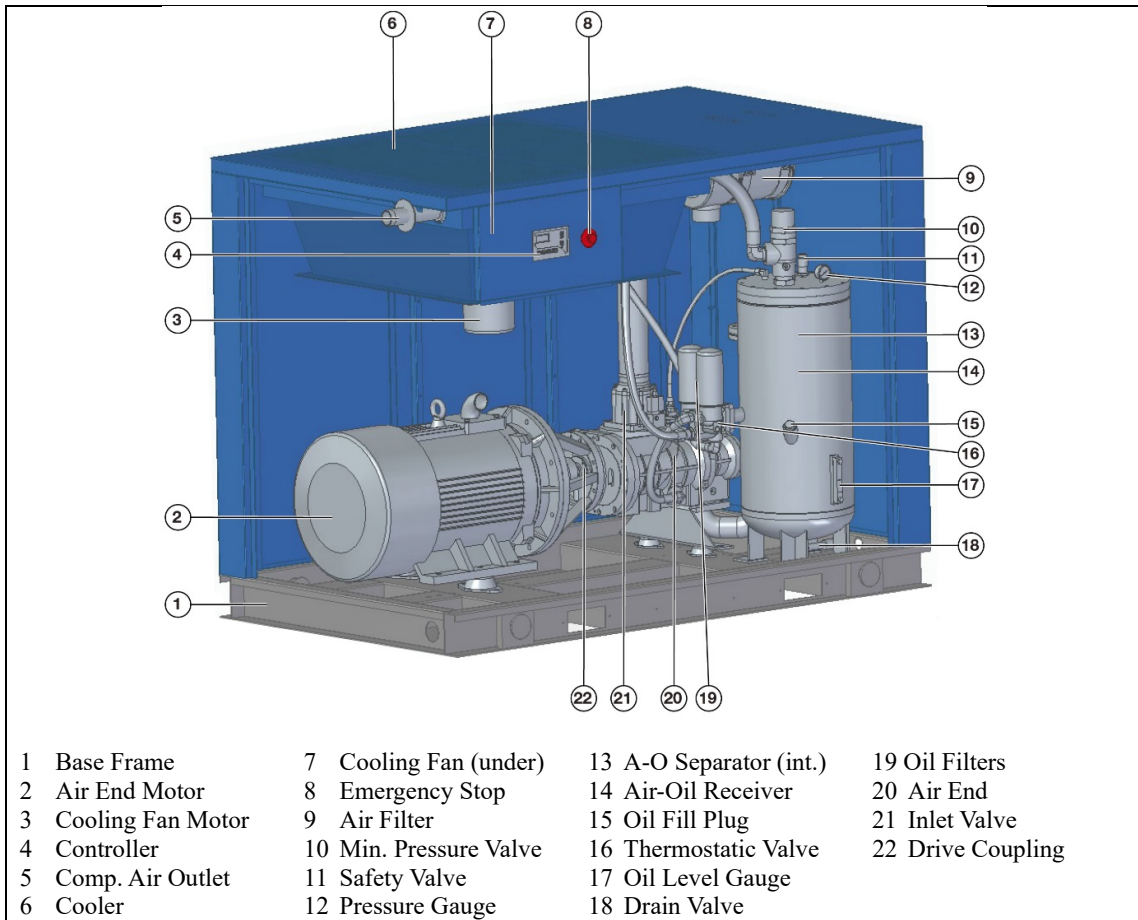

Figure 2-2(c): Structure of a DSV Series Air Compressor Set - Models DSV55 to DSV90

2.4 Specifications

Compressor Model	DSV8	DSV11
Air Discharge (m³/min)		
@ 8 bar	0.41 - 1.02	0.66 - 1.65
@ 10 bar	0.38 - 0.95	0.60 - 1.50
@ 13 bar	0.33 - 0.83	0.56 - 1.40
Air Discharge Temperature (°C)	≤ Ambient + 15	
Oil Content in Discharge Air (ppm)	≤ 3 w/w	
Lubricating Oil Capacity (L)	≈ 8	≈ 8
Ambient Design Conditions	0°C ≤ T ≤ 45°C, P = 101.325 kPa, RH ≤ 80%	
Driving Mode	Variable Speed Electric Motor with V-Belt Drive	
Cooling Mode	Fan-Forced Oil Cooler and Air After-Cooler	
Motor Starting Mode	Electronic Variable Speed Drive	
Temperature Control Mode	Thermostatic Valve	
Thermostatic Valve Setting (°C)	8 & 10 bar: 71 Nominal (66 ~ 77 Range) 13 bar: 83 Nominal (79 ~ 88 Range)	
Input Power Supply (V / Ph / Hz)	400 / 3 / 50	
Input Power Supply (A) @ Rated PF	≈ 16.4	≈ 23.7
Air End Motor Power (kW / hp)	7.5 / 10	11 / 15
Air End Motor Speed (rpm)	1,172 - 2,930	1,172 - 2,930
Protection: Air End Motor	IP55	
Fan Motor Power / Speed (kW / rpm)	n/a	n/a
Protection: Fan Motor	n/a	
Protection: Compressor Cabinet	Top: ≥ IP4X	Sides: ≥ IP2X
Noise Level @ 1 m (dB(A))	68	68
Discharge Air Pipe Connection	¾ inch BSP Female	¾ inch BSP Female
Air-Oil Receiver Volume (L)	15	15
Air-Oil Separator Type	Internal Cartridge	
Min. Press. Valve Setting (bar)	4.5 ± 0.5	
Overall Dimensions: W × D × H (cm)	88 × 88 × 108	88 × 88 × 108
Weight (kg)	318	368
Air End Pulley:		
8 bar	SPZ × 95 × 3	SPZ × 95 × 3
Type × PCD × Grooves		
10 bar	SPZ × 106 × 3	SPZ × 100 × 3
13 bar	SPZ × 125 × 3	SPZ × 106 × 3
Air End Pulley Taper Bush:		
8 bar	1610 × 25	1610 × 25
Model × Bore		
10 bar	1610 × 25	1610 × 25
13 bar	2012 × 25	1610 × 25
Motor Pulley:		
8 bar	SPZ × 112 × 3	SPZ × 170 × 3
Type × PCD × Grooves		
10 bar	SPZ × 112 × 3	SPZ × 150 × 3
13 bar	SPZ × 112 × 3	SPZ × 150 × 3
Motor Pulley Taper Bush:		
8 bar	2012 × 42	2012 × 42
Model × Bore		
10 bar	2012 × 42	2012 × 42
13 bar	2012 × 42	2012 × 42
V-Belts:		
8 bar	3 × XPZ-1037	3 × XPZ-1120
Quantity × Type-Size		
10 bar	3 × XPZ-1037	3 × XPZ-1087
13 bar	3 × XPZ-1087	3 × XPZ-1120

Compressor Model	DSV15	DSV18	DSV22
Air Discharge (m³/min) @ 8 bar	0.96 - 2.40	1.18 - 2.95	1.44 - 3.60
@ 10 bar	0.82 - 2.05	1.02 - 2.55	1.36 - 3.40
@ 13 bar	0.74 - 1.85	0.92 - 2.30	1.20 - 3.00
Air Discharge Temperature (°C)	≤ Ambient + 15		
Oil Content in Discharge Air (ppm)	≤ 3 w/w		
Lubricating Oil Capacity (L)	≈ 8	≈ 12	≈ 12
Ambient Design Conditions	0°C ≤ T ≤ 45°C, P = 101.325 kPa, RH ≤ 80%		
Driving Mode	Variable Speed Electric Motor with V-Belt Drive		
Cooling Mode	Fan-Forced Oil Cooler and Air After-Cooler		
Motor Starting Mode	Electronic Variable Speed Drive		
Temperature Control Mode	Thermostatic Valve		
Thermostatic Valve Setting (°C)	8 & 10 bar: 71 Nominal (66 ~ 77 Range) 13 bar: 83 Nominal (79 ~ 88 Range)		
Input Power Supply (V / Ph / Hz)	400 / 3 / 50		
Input Power Supply (A) @ Rated PF	≈ 32.1	≈ 39.3	≈ 46.3
Air End Motor Power (kW / hp)	15 / 20	18.5 / 25	22 / 30
Air End Motor Speed (rpm)	1,172 - 2,930	1,172 - 2,930	1,180 - 2,950
Protection: Air End Motor	IP55		
Fan Motor Power / Speed (kW / rpm)	n/a	0.55 / 1,440	0.55 / 1,440
Protection: Fan Motor	n/a	IP54	IP54
Protection: Compressor Cabinet	Top: ≥ IP4X Sides: ≥ IP2X		
Noise Level @ 1 m (dB(A))	70	70	70
Discharge Air Pipe Connection	¾ inch BSP Female	1¼ inch BSP F	1¼ inch BSP F
Air-Oil Receiver Volume (L)	15	22	22
Air-Oil Separator Type	Internal Cartridge		
Min. Press. Valve Setting (bar)	4.5 ± 0.5		
Overall Dimensions: W × D × H (cm)	96 × 99 × 108	114 × 88 × 126	114 × 88 × 126
Weight (kg)	451	512	548
Air End Pulley: 8 bar	SPA × 125 × 3	SPA × 118 × 3	SPA × 106 × 3
Type × PCD × Grooves 10 bar	SPA × 140 × 3	SPA × 132 × 3	SPA × 118 × 3
13 bar	SPA × 160 × 3	SPA × 140 × 3	SPA × 132 × 3
Air End Pulley Taper Bush: 8 bar	2012 × 35	2012 × 35	1610 × 35
Model × Bore 10 bar	2517 × 35	2012 × 35	2012 × 35
13 bar	2517 × 35	2517 × 35	2012 × 35
Motor Pulley: 8 bar	SPA × 160 × 3	SPA × 180 × 3	SPA × 200 × 3
Type × PCD × Grooves 10 bar	SPA × 160 × 3	SPA × 180 × 3	SPA × 200 × 3
13 bar	SPA × 160 × 3	SPA × 180 × 3	SPA × 200 × 3
Motor Pulley Taper Bush: 8 bar	2517 × 42	2517 × 42	2517 × 48
Model × Bore 10 bar	2517 × 42	2517 × 42	2517 × 48
13 bar	2517 × 42	2517 × 42	2517 × 48
V-Belts: 8 bar	3 × XPA-1132	3 × XPA-1207	3 × XPA-1250
Quantity × Type-Size 10 bar	3 × XPA-1157	3 × XPA-1232	3 × XPA-1250
13 bar	3 × XPA-1180	3 × XPA-1250	3 × XPA-1282

Compressor Model	DSV30	DSV37	DSV45
Air Discharge (m³/min) @ 8 bar	2.08 - 5.20	2.52 - 6.30	3.04 - 7.60
@ 10 bar	1.84 - 4.60	2.30 - 5.75	2.76 - 6.90
@ 13 bar	1.62 - 4.05	2.02 - 5.05	2.52 - 6.30
Air Discharge Temperature (°C)	≤ Ambient + 15		
Oil Content in Discharge Air (ppm)	≤ 3 w/w		
Lubricating Oil Capacity (L)	≈ 18	≈ 18	≈ 30
Ambient Design Conditions	0°C ≤ T ≤ 45°C, P = 101.325 kPa, RH ≤ 80%		
Driving Mode	Variable Speed Electric Motor with V-Belt Drive		
Cooling Mode	Fan-Forced Oil Cooler and Air After-Cooler		
Motor Starting Mode	Electronic Variable Speed Drive		
Temperature Control Mode	Thermostatic Valve		
Thermostatic Valve Setting (°C)	8 & 10 bar: 71 Nominal (66 ~ 77 Range) 13 bar: 83 Nominal (79 ~ 88 Range)		
Input Power Supply (V / Ph / Hz)	400 / 3 / 50		
Input Power Supply (A) @ Rated PF	≈ 62.8	≈ 76.6	≈ 96.3
Air End Motor Power (kW / hp)	30 / 40	37 / 50	45 / 60
Air End Motor Speed (rpm)	1,180 - 2,950	1,182 - 2,955	1,188 - 2,970
Protection: Air End Motor	IP55		
Fan Motor Power / Speed (kW / rpm)	0.75 / 1,420	0.75 / 1,420	1.1 / 940
Protection: Fan Motor	IP54		
Protection: Compressor Cabinet	Top: ≥ IP4X Sides: ≥ IP2X		
Noise Level @ 1 m (dB(A))	72	72	75
Discharge Air Pipe Connection	1½ inch BSP F	1½ inch BSP F	2 inch BSP Female
Air-Oil Receiver Volume (L)	34	34	66
Air-Oil Separator Type	Internal Cartridge		
Min. Press. Valve Setting (bar)	4.5 ± 0.5		
Overall Dimensions: W × D × H (cm)	100 × 125 × 131	100 × 125 × 131	140 × 110 × 160
Weight (kg)	733	778	989
Air End Pulley: 8 bar	SPA × 150 × 4	SPA × 150 × 4	SPB × 140 × 4
Type × PCD × Grooves 10 bar	SPA × 150 × 4	SPA × 150 × 4	SPB × 150 × 4
13 bar	SPA × 150 × 4	SPA × 150 × 4	SPB × 180 × 4
Air End Pulley Taper Bush: 8 bar	2517 × 42	2517 × 42	2517 × 48
Model × Bore 10 bar	2517 × 42	2517 × 42	2517 × 48
13 bar	2517 × 42	2517 × 42	2517 × 48
Motor Pulley: 8 bar	SPA × 180 × 4	SPA × 224 × 4	SPB × 224 × 4
Type × PCD × Grooves 10 bar	SPA × 170 × 4	SPA × 200 × 4	SPB × 212 × 4
13 bar	SPA × 140 × 4	SPA × 190 × 4	SPB × 212 × 4
Motor Pulley Taper Bush: 8 bar	2517 × 55	3020 × 55	3020 × 55
Model × Bore 10 bar	2517 × 55	3020 × 55	3020 × 55
13 bar	2517 × 55	2517 × 55	3020 × 55
V-Belts: 8 bar	4 × XPA-1332	4 × XPA-1400	4 × XPB-1450
Quantity × Type-Size 10 bar	4 × XPA-1332	4 × XPA-1382	4 × XPB-1450
13 bar	4 × XPA-1282	4 × XPA-1357	4 × XPB-1450

Compressor Model	DSV55-8-10	DSV55-13
Air Discharge (m³/min) @ 8 bar	3.84 - 9.60	3.24 - 8.10
@ 10 bar	3.84 - 8.26	3.24 - 8.10
@ 13 bar	n/a	3.24 - 8.10
Air Discharge Temperature (°C)	≤ Ambient + 15	
Oil Content in Discharge Air (ppm)	≤ 3 w/w	
Lubricating Oil Capacity (L)	≈ 55	≈ 55
Ambient Design Conditions	0°C ≤ T ≤ 45°C, P = 101.325 kPa, RH ≤ 80%	
Driving Mode	Variable Speed Electric Motor with Direct-Coupled Gear Drive	
Cooling Mode	Fan-Forced Oil Cooler and Air After-Cooler	
Motor Starting Mode	Electronic Variable Speed Drive	
Temperature Control Mode	Thermostatic Valve	
Thermostatic Valve Setting (°C)	8 & 10 bar: 71 Nominal (66 ~ 77 Range) 13 bar: 83 Nominal (79 ~ 88 Range)	
Input Power Supply (V / Ph / Hz)	400 / 3 / 50	
Input Power Supply (A) @ Rated PF	≈ 118.4	
Air End Motor Power (kW / hp)	55 / 75	
Air End Motor Speed (rpm)	1,188 - 2,970	
Protection: Air End Motor	IP55	
Fan Motor Power / Speed (kW / rpm)	2.2 / 940	
Protection: Fan Motor	IP54	
Protection: Compressor Cabinet	Top: ≥ IP4X Sides: ≥ IP2X	
Noise Level @ 1 m (dB(A))	75	75
Discharge Air Pipe Connection	2 inch BSP Female	2 inch BSP Female
Air-Oil Receiver Volume (L)	110	110
Air-Oil Separator Type	Internal Cartridge	
Min. Press. Valve Setting (bar)	4.5 ± 0.5	
Overall Dimensions: W × D × H (cm)	225 × 134 × 169	225 × 134 × 169
Weight (kg)	1,590	1,590

Compressor Model	DSV75-8-10	DSV75-13
Air Discharge (m³/min) @ 8 bar	5.20 - 13.00	4.10 - 10.25
@ 10 bar	5.20 - 11.18	4.10 - 10.25
@ 13 bar	n/a	4.10 - 10.25
Air Discharge Temperature (°C)	≤ Ambient + 15	
Oil Content in Discharge Air (ppm)	≤ 3 w/w	
Lubricating Oil Capacity (L)	≈ 60	≈ 60
Ambient Design Conditions	0°C ≤ T ≤ 45°C, P = 101.325 kPa, RH ≤ 80%	
Driving Mode	Variable Speed Electric Motor with Direct-Coupled Gear Drive	
Cooling Mode	Fan-Forced Oil Cooler and Air After-Cooler	
Motor Starting Mode	Electronic Variable Speed Drive	
Temperature Control Mode	Thermostatic Valve	
Thermostatic Valve Setting (°C)	8 & 10 bar: 71 Nominal (66 ~ 77 Range) 13 bar: 83 Nominal (79 ~ 88 Range)	
Input Power Supply (V / Ph / Hz)	400 / 3 / 50	
Input Power Supply (A) @ Rated PF	≈ 159.0	
Air End Motor Power (kW / hp)	75 / 100	
Air End Motor Speed (rpm)	1,190 - 2,975	
Protection: Air End Motor	IP55	
Fan Motor Power / Speed (kW / rpm)	2.2 / 940	
Protection: Fan Motor	IP54	
Protection: Compressor Cabinet	Top: ≥ IP4X Sides: ≥ IP2X	
Noise Level @ 1 m (dB(A))	75	75
Discharge Air Pipe Connection	2 inch BSP Female	2 inch BSP Female
Air-Oil Receiver Volume (L)	110	110
Air-Oil Separator Type	Internal Cartridge	
Min. Press. Valve Setting (bar)	4.5 ± 0.5	
Overall Dimensions: W × D × H (cm)	225 × 134 × 169	225 × 134 × 169
Weight (kg)	1,750	1,750

Compressor Model	DSV90-8-10	DSV90-13
Air Discharge (m³/min)		
@ 8 bar	6.08 - 15.20	4.92 - 12.30
@ 10 bar	6.08 - 13.07	4.92 - 12.30
@ 13 bar	n/a	4.92 - 12.30
Air Discharge Temperature (°C)	≤ Ambient + 15	
Oil Content in Discharge Air (ppm)	≤ 3 w/w	
Lubricating Oil Capacity (L)	≈ 65	≈ 65
Ambient Design Conditions	0°C ≤ T ≤ 45°C, P = 101.325 kPa, RH ≤ 80%	
Driving Mode	Variable Speed Electric Motor with Direct-Coupled Gear Drive	
Cooling Mode	Fan-Forced Oil Cooler and Air After-Cooler	
Motor Starting Mode	Electronic Variable Speed Drive	
Temperature Control Mode	Thermostatic Valve	
Thermostatic Valve Setting (°C)	8 & 10 bar: 71 Nominal (66 ~ 77 Range) 13 bar: 83 Nominal (79 ~ 88 Range)	
Input Power Supply (V / Ph / Hz)	400 / 3 / 50	
Input Power Supply (A) @ Rated PF	≈ 191.3	
Air End Motor Power (kW / hp)	90 / 120	
Air End Motor Speed (rpm)	1,190 - 2,975	
Protection: Air End Motor	IP55	
Fan Motor Power / Speed (kW / rpm)	3 .0 / 1,440	
Protection: Fan Motor	IP54	
Protection: Compressor Cabinet	Top: ≥ IP4X Sides: ≥ IP2X	
Noise Level @ 1 m (dB(A))	75	75
Discharge Air Pipe Connection	2 inch BSP Female	2 inch BSP Female
Air-Oil Receiver Volume (L)	150	150
Air-Oil Separator Type	Internal Cartridge	
Min. Press. Valve Setting (bar)	4.5 ± 0.5	
Overall Dimensions: W × D × H (cm)	225 × 134 × 169	225 × 134 × 169
Weight (kg)	1,770	1,770

2.5 Discharge Pressure Options

The Senator DSV Series compressors are available in 8, 10 or 13 bar maximum discharge pressure configuration.

Models DSV8 to DSV45 are supplied as standard in 8 bar configuration. They can be converted to 10 bar configuration by changes to the V-belt drive components and controller parameters. For 13 bar configuration, the thermostatic valve element must also be changed. The requirement for 10 or 13 bar configuration should be communicated at the time of initial purchase so that the necessary changes can be made and tested by the distributor in Australia before dispatch to the installation site.

Models DSV55, DSV75 and DSV90 are supplied as standard in 8 bar configuration. They can be altered to provide 10 bar discharge pressure by changing the controller parameters. Again, the requirement for 10 bar configuration should be communicated at the time of initial purchase.

13 bar versions of models DSV55, DSV75 and DSV90 must be ordered from the outset with this pressure configuration. It is not practicable to change the compressor's direct-coupled gear drive ratio after its manufacture.

Please consult your local Senator dealer for application-specific advice.

3.0 Installation

3.1 Overall Dimensions

The dimensions in the general arrangement drawings shown below are in millimetres (mm) unless noted otherwise.

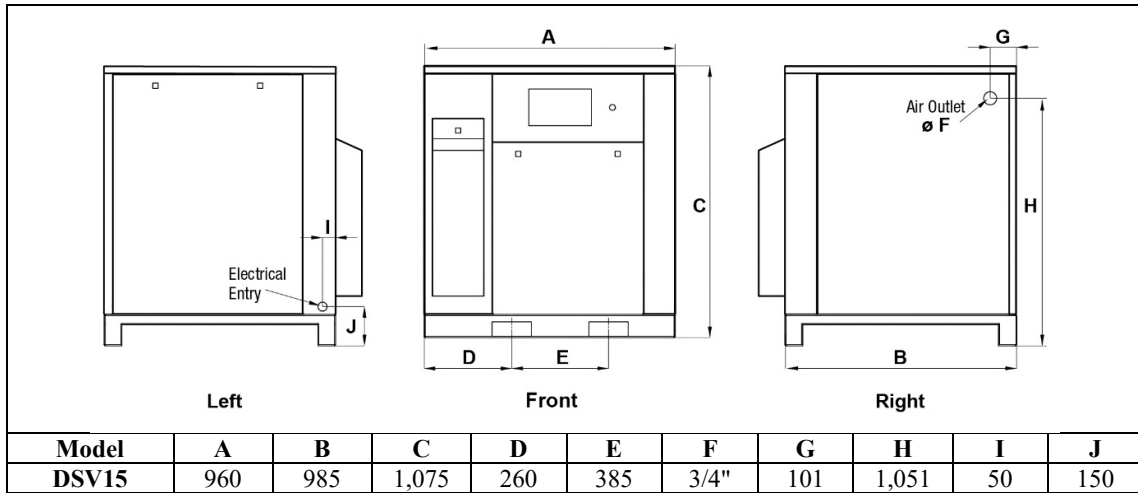
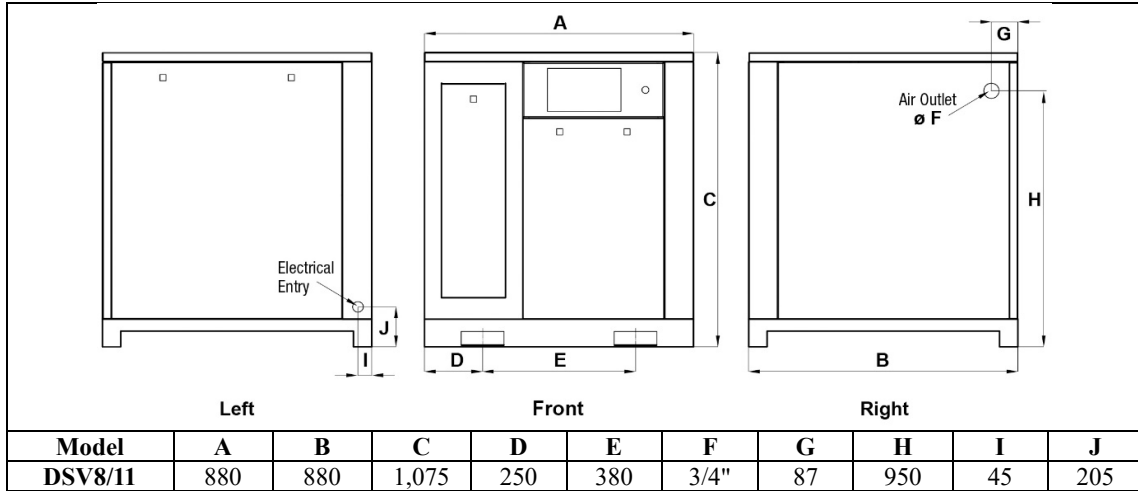

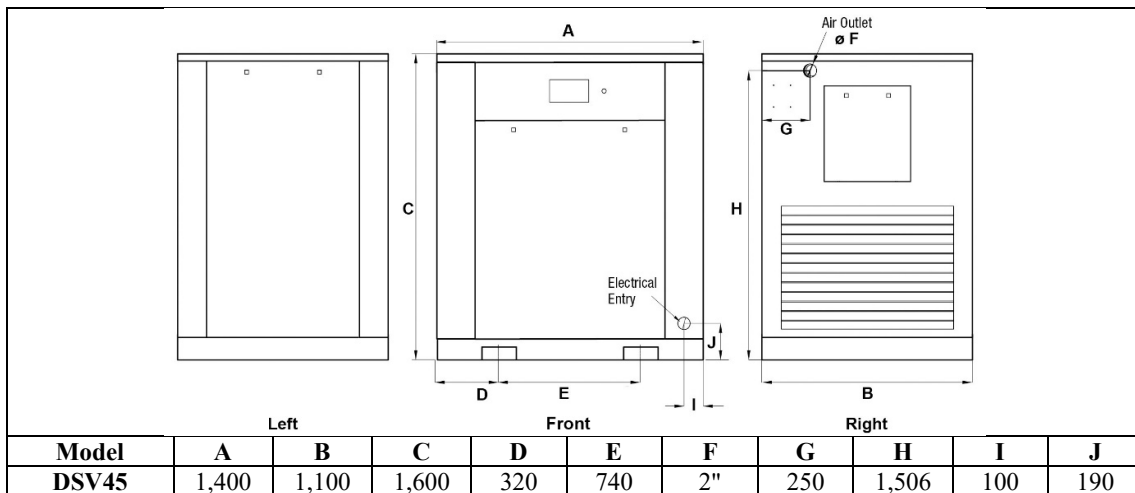
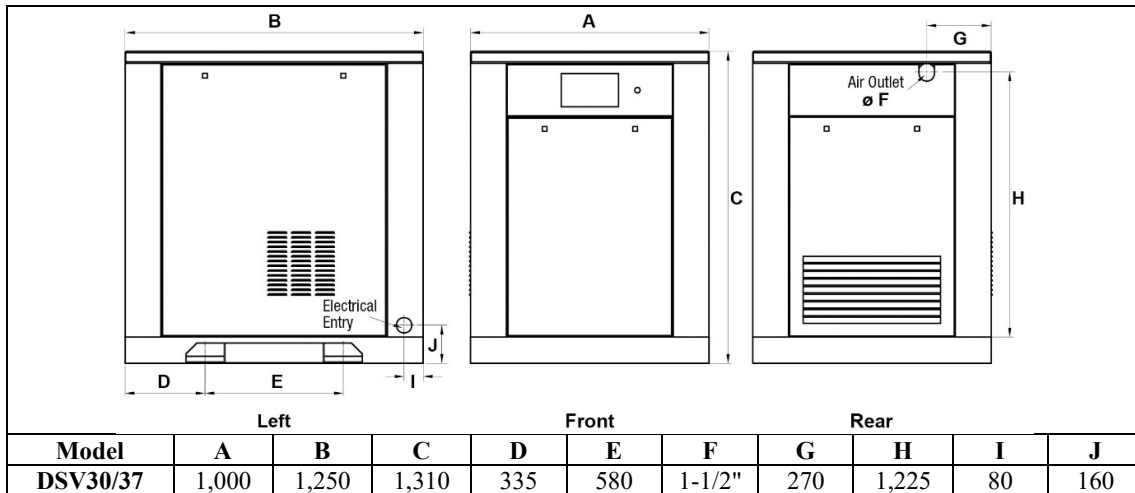
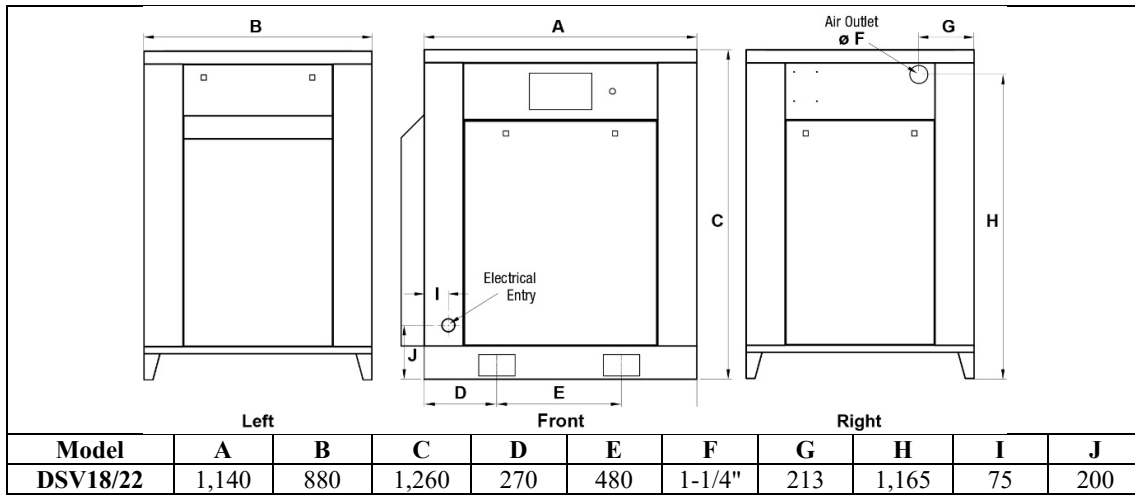

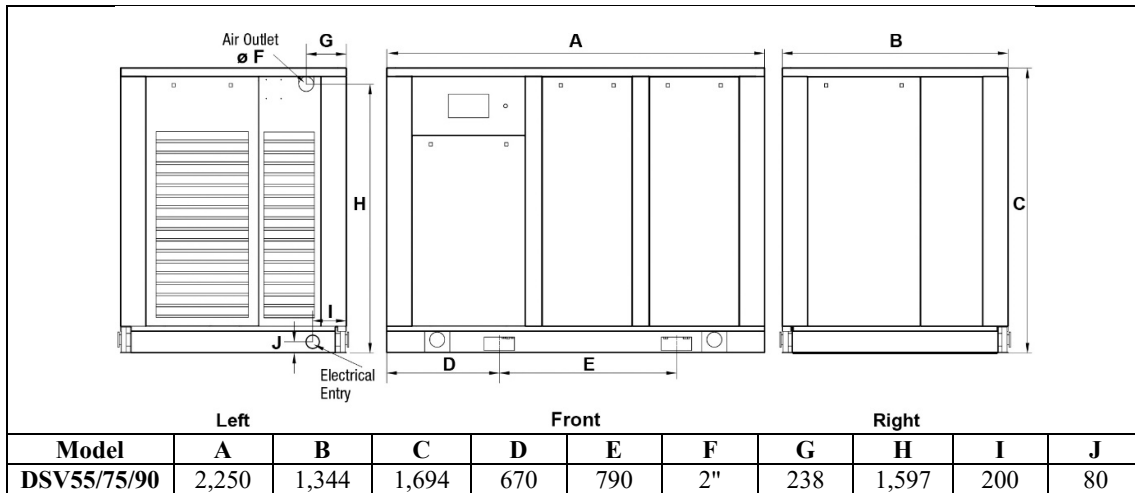

3.2 Site Conditions

A proper installation site should be selected for the compressor. It is recommended to use a dedicated compressor room. The installation site should meet the following requirements:

- a. It is essential to install the compressor in an area with good lighting and sufficient free space for unhindered operation and maintenance. The compressor should have a clearance of no less than 1.2 ~ 1.5 m from its front and 0.6 ~ 0.9 m from its sides and rear. The ceiling height should be at least 2.4 m from floor level.
- b. Good ventilation is essential to ensure that the indoor ambient temperature is kept to a minimum; it should never exceed 45°C. As a conservative rule of thumb, the compressor room should be provided with 750 m³/h of cooling airflow per kW of rated motor power. The unobstructed ventilation openings for the inlet and outlet cooling airflows should each be 0.1 m² per kW of rated motor power and the cooling air velocity should not exceed 2 m/s. For example, the recommended cooling airflow to suit a DSV37 compressor, for example, is 37 × 750 = 27,750 m³/h and the ventilation opening area is 37 × 0.1 = 3.7 m² each for the inlet and outlet.
- c. The ambient air should be clean and free of solid, liquid or gaseous contamination. It should have low relative humidity, low dust content and no corrosive, explosive or inflammable substances present. If the air quality fails to reach these requirements, it will be necessary to provide clean air entry into the compressor room from a remote source or install pre-filtration equipment.
- d. The compressor should be installed in a horizontal position on a solid, flat foundation. Mounting holes are provided in the compressor’s base frame through which it should be affixed to the floor with hold-down fasteners. Do not bolt an apparently uneven base frame tightly to the foundation as this will cause excessive stress on the compressor’s structure. Use metal shims to pack under any gaps, if necessary; this is most often due to the floor surface not being perfectly level rather than the base frame being uneven. The unit is designed for stationary duty only.

- e. The compressor should be installed in a well-ventilated area most preferably indoors. If it has to be located outdoors, the unit must be provided with protection from precipitation (or other liquids) and direct sunlight.

3.3 Electricity Supply

Table 3-1: Electrical Power Supply Requirements

Air Compressor Model	Main Motor Rating (kW)	Main Motor Starting Method	Maximum Running Current (A)	Minimum Circuit Breaker Rating (A)	Circuit Breaker Tripping Curve
DSV8	7.5	VSD	16.4	25	B, C or D
DSV11	11	VSD	23.7	32	B, C or D
DSV15	15	VSD	32.1	40	B, C or D
DSV18	18.5	VSD	39.3	50	B, C or D
DSV22	22	VSD	46.3	63	B, C or D
DSV30	30	VSD	62.8	80	B, C or D
DSV37	37	VSD	76.6	100	B, C or D
DSV45	45	VSD	96.3	125	B, C or D
DSV55	55	VSD	118.4	160	B, C or D
DSV75	75	VSD	159.0	200	B, C or D
DSV90	90	VSD	191.3	250	B, C or D

With reference to the guidance provided in Table 3-1 above:

- The compressor requires a three-phase mains power supply stabilised at nominally 400 Volts (or 415 Volts) and 50 Hertz. A portable electric generator is not recommended for powering the compressor unless it has ample generating capacity to supply both the requisite starting and running current demands without appreciable voltage or frequency drop.
- All electrical installation work must be performed by a licensed electrician in accordance with the AS/NZS 3000:2018 Wiring Rules.
- A separate electricity supply circuit is recommended for the compressor to avoid motor current overload due to excessive voltage drop or an unbalanced three-phase condition caused by other electrical equipment operating in parallel.
- For additional protection against electric shock, it is recommended to include a fixed setting residual current device (RCD) with rated operating residual current not exceeding 30 mA. Special RCDs should be considered for use with high current or variable speed drives (VSDs) to prevent nuisance tripping.
- The minimum circuit breaker sizes are a general guide only for dedicated supply to the compressor. A four-wire conductor is required for the electricity supply, i.e. three-phase and earth only (no neutral).

- f. The maximum running current may exceed the specified value in practice if the electricity supply voltage or power factor are below their rated levels.
- g. The variable speed drive (VSD) unit ensures that the air end motor always rotates in the correct direction. However, if the phase sequence rotation is incorrect the electric cooling fan motor (if equipped) will rotate backwards and the compressor will overheat. Check that the discharge air from the electric cooling fan is blowing upwards and away from the compressor cabinet. If not, a licensed electrician must reverse the phase sequence rotation by interchanging any two phases of the three-phase power supply connection.

3.4 Compressed Air Storage and Treatment

The compressor must be connected to an external pressure vessel downstream commonly referred to as an air receiver or air tank otherwise it will not operate properly. The air receiver provides a buffer storage volume of compressed air, smooths out pulsations from the compressor, cools the air and collects condensation. Consequently, the air receiver must be fitted with a condensate drainage device (valve).

In the absence of detailed application-specific calculations, the compressor should be connected to an external air receiver with no less storage volume than that listed in Table 3-2. In general, bigger is better with respect to air receiver sizing.

Most applications require clean and dry compressed air of substantially better quality than that discharged from the compressor. This is achieved in practice by equipping the compressed air system with downstream dryer(s) and filter(s) to remove unwanted water, oil and particulate matter. Please consult your local Senator dealer for advice.

Table 3-2: External Air Receiver Sizing

Air Compressor Model	Minimum Air Receiver Volume (litres)
DSV8	130
DSV11	210
DSV15	300
DSV18	370
DSV22	450
DSV30	650
DSV37	790
DSV45	950
DSV55	1,200
DSV75	1,630
DSV90	1,900

4.0 Operation

Before compressor start-up, the operator should thoroughly read and understand this manual and become familiar with the compressor's features. The operator should comply with all the instructions and especially the safety notices.



4.1 Initial Start-Up

- a. Remove the compressor from its packing carton and shipping skid. Use a forklift to lift the compressor by means of the fork blade pockets in the base frame. Caution: The unit's centre-of-gravity may be offset from its physical centreline depending upon its internal layout. Note especially the positions of the relatively heavy air end motor and air end components.
- b. Secure the compressor onto its foundation in a suitable location.
- c. Install the compressor's outlet valve (supplied loose) and connect the unit to the compressed air network. Keep the outlet valve closed.
- d. Remove the two shipping bolts attached between the base frame and base plate as shown in Figure 4-1.



Figure 4-1: Shipping Bolt

- e. Connect the power supply cable and the earth cable (if separate). Check that the voltage is correct and equal on all three phases.
- f. Check whether the electrical wiring is safe, secure and reliable.
- g. Check whether the oil level in the air-oil receiver is OK.
- h. Check whether the V-belt tension is correct.
- i. Before start-up of the compressor after three or more months of shutdown or storage, add a small amount of clean compressor lubricating oil directly into the compressor through the air inlet valve and then rotate the screw air end for several turns by hand. This is to prevent friction or heat damage to the screw air end due to insufficient lubrication upon initial start-

- up. Use about 0.25 L of oil for models DSV8 to DSV15 and 0.5 L for the larger models.
- j. Open the compressor's outlet valve.
- k. Rotation direction test: Although the compressor has built-in reverse phase sequence protection for the air end motor, the rotation direction test is still an important step in the initial start-up. It should also be carried out whenever the motor is repaired or replaced.
- l. Press the Start button  and then immediately press the Emergency Stop button when the air end motor shaft begins to rotate. Make sure that the rotation direction of the motor is consistent with the direction arrow marked on the air end. If it is incorrect, please contact the compressor manufacturer for assistance.
- m. The rotation direction of the fan motor, if equipped, should also be checked. The cooling air should discharge upwards and away from the exhaust vents on top of the unit. If it doesn't, a licensed electrician must reverse the phase sequence rotation by interchanging any two phases of the power supply connection. After completing these motor rotation checks and making any necessary adjustments, release the Emergency Stop button by turning it clockwise.
- n. Restart the compressor. The unit will automatically commence operating. Stop or limit any downstream compressed air use so that the system pressure can rise until the unit switches to unloading mode. Check whether the unloading pressure is consistent with the pre-programmed setting and observe whether the controller shows all monitored parameters are within their normal ranges. If any abnormal sound, vibration or leakage occurs, immediately press the Emergency Stop button to shut down the machine for inspection.
- o. Shutdown: Press the Stop button . The unit will enter the unloading mode and the compressor vent valve will discharge the internal system air. After 30 seconds, the unit will stop. During normal operation, do not use the Emergency Stop button to shut down the compressor.

4.2 Daily Operation

4.2.1 Start-Up

Caution: Ensure that the air-oil receiver is not pressurised before opening its drain valve or removing its oil fill plug.

- a. Remove the plug and carefully open the ball valve at the bottom of the air-oil receiver to drain out any water condensate. Close the drain valve immediately when lubricating oil starts to flow out and then re-install the plug. This task should be undertaken when the unit is cold prior to use.
- b. Check the compressor's oil level in accordance with the instructions given in Section 5.0.
- c. Open the air outlet valve on the side of the compressor cabinet.
- d. Start-up any peripheral compressed air equipment such as an air dryer.

- e. Press the Start button **1** on the compressor.
- f. After the operation is in steady state, check the discharge pressure and temperature readings. The pressure should remain within the limits of the 'load' and 'unload' pressure settings provided that the compressor and air storage capacity are large enough for the application. The air end discharge temperature will typically vary between approximately 71 to 83°C (for 8 or 10 bar configuration) or 80 to 90°C (for 13 bar configuration) depending upon the unit's operating conditions. The temperature should not exceed 104°C.
- g. If any abnormal condition is found, turn off and isolate the compressor for inspection. Only restart the unit after rectifying the problem.

4.2.2 Operating Modes

Starting

Press the Start button **1**. The contactor in the electrical cabinet will close to start the main drive motor. At this point, the throttle in the inlet valve will be closed, and only a low volume of air enters the compressor through the check valve in the inlet valve. The compressor starts at reduced load and then the system pressure gradually increases in the air-oil receiver.

Loading

Either 10 or 13 seconds after starting, depending on the model, the solenoid actuated inlet valve opens fully so that a high volume of air can enter the compressor to enable loading mode operation. When the pressure inside the air-oil receiver reaches approximately 4.5 bar, the minimum pressure valve opens and the unit starts to discharge into the downstream compressed air network.

The compressor's motor speed will vary over a range not exceeding 40 to 100%, depending on the model, as the unit tries to maintain the target pressure level at the air outlet notwithstanding fluctuations in the air demand. The target pressure ('Target P') can only be set within the limits of the minimum ('Load P') and maximum ('Unload P') operating pressures.

Unloading

If the air consumption remains below the compressor's minimum discharge flowrate, the discharge pressure of the unit will reach the unload pressure setting. At this point, the inlet valve closes to stop air input. The check valve spool of the minimum pressure valve is closed to isolate the compressor from the compressed air network. The vent valve opens to reduce the pressure in the air-oil receiver down to approximately 4.5 bar, thereby reducing the operating back pressure within the compressor's air circuit and maintaining lubricating oil circulation.

In unloading mode, if the pressure at the air outlet decreases to the load pressure set point, the controller actuates the solenoid to open the inlet valve and close the vent valve. The unit is thus returned to the loading operation state.

If the unit fails to stop loading operation at the correct unloading set point pressure, it may cause

the safety valve installed in the air-oil receiver to open for system pressure relief, thereby avoiding any hazard due to excessively high system pressure. If this occurs, immediately shut down the unit and check the inlet valve and controller for their correct operation and settings.

Stand-By



If the compressor operates continuously in unloading mode for five minutes, the controller assumes that air consumption has ceased and switches the compressor to stand-by mode. The air end motor and fan motor, if equipped, will stop rotating to save energy.

In stand-by mode, if air consumption is resumed and pressure at the air outlet decreases to the loading set point, the controller will restart the unit automatically.

Caution: The controller's display will indicate 'AutoStop' whenever the compressor is in stand-by mode. In such a state, the compressor cabinet doors should not be opened and no maintenance work should be carried out due to the risk of injury if the unit restarts automatically.

4.2.3 Shutdown

Normal Shutdown

If compressed air is no longer required, for example at lunchtime or end of the working day, pressing the Stop button  will initiate the compressor's normal shutdown sequence. The unit will either switch to or remain in unloading mode for 30 seconds to stabilise the internal air and oil systems before ceasing operation altogether. After a further 60 seconds, the unit can only be restarted by pressing the Start button .

After shutdown, the air outlet valve should be closed to protect the unit against the influence of compressed air in the external pipeline network.

Caution: The compressor VSD's cooling fan(s) may continue to operate for a short while after the compressor has shut down. Do not switch off or disconnect the unit's power supply during this time except in the case of emergency or for urgent maintenance.

Fault Alarm Shutdown

If any monitored electrical, pressure or temperature fault is detected, the controller or VSD will shut down the compressor immediately. If this happens, the fault should be investigated and rectified according to the indication on the controller's or VSD's display screen. Press and then release unlock the Emergency Stop button after rectifying a fault to clear the shutdown alarm message on the controller. Press the Stop Reset button on the VSD after rectifying a VSD fault to clear the shutdown alarm message on the VSD. Depending on the fault, it may be necessary to switch the mains power supply off for five minutes to reset the VSD.

Emergency Shutdown

If any abnormal condition arises during compressor operation, press the Emergency Stop button immediately for direct shut down of the unit to avoid any damage or injury. The fault should then be investigated and rectified before resetting the controller.

4.2.4 Monitoring During Operation

- a. Observe whether the compressor is emitting any abnormal noise or vibration. If present, an immediate shutdown should be performed.
- b. Do not loosen any pipes, bolts, threaded joints or electrical connections in the compressor when it's switched on or running. Any individual valves in the unit shouldn't be opened or closed at random.
- c. Observe the oil level. When cold prior to running, the oil level should be in the upper range between the medium ('M') and high ('H') levels. When running in loading mode, the oil level should stabilise in between the low ('L') and medium ('M') levels. Top-up the oil level as required and do not overfill it.
- d. The operator on each shift should keep a written log recording the discharge pressure, discharge temperature, motor currents, oil level, run time, etc. and any maintenance or repair work carried out on the compressor.

4.2.5 Duty Cycle

The compressor is ideally suited for applications with fluctuating compressed air demand between 40 and 100% of the unit's rated free air delivery.

During periods of very low air demand, the unit may not reach its normal operating temperature with sufficient frequency or duration. Sustained operation at very low duty cycle can result in a build-up of water condensate within the lubricating oil. If this occurs, the lubricating characteristics of the oil can be impaired and this may cause serious internal damage to the unit which is not a warrantable fault.

The compressor should be allowed ample running time in loading mode of at least 10 minutes per hour when in use to prevent such accumulation of condensate in the lubricating oil.

4.3 Long-Term Shutdown

4.3.1 Preparation

If the compressor is to be shut down for longer than one month, the following steps should first be performed:

- a. Any faults should be rectified in preparation for the unit's future use.
- b. The water condensate in the air-oil receiver should be completely drained out to prevent internal corrosion.
- c. All openings should be enclosed with plastic cloth or oiled paper to prevent the ingress of moisture and dust.

If the unit is to be out of service for more than two months, replace the lubricating oil beforehand

and then run the compressor for 30 minutes. After three days, the water condensate in the air-oil receiver should be completely drained out.

4.3.2 Re-start

- a. Remove the protective plastic cloth or oiled paper.
- b. Measure the insulation resistance of motors to ground, which should be more than 1 M Ω .
- c. Follow the initial start-up procedure described in Section 4.1 to re-start the unit.

5.0 Maintenance

Before performing any maintenance work on the compressor, switch off the unit, isolate and tag-out the power supply, carefully release any residual air pressure from the internal air-oil receiver and any connected downstream piping in the user's network, and close the air outlet valve. And if possible, allow the unit to cool down if it's been running.

Before performing any maintenance work on the compressor's variable speed drive (VSD), switch off the unit, isolate and tag-out the power supply, and wait 10 minutes. Check that the VSD's capacitors have fully discharged by measuring the DC voltage between their positive and negative terminals, which should be less than 25 V DC.

5.1 Lubricating Oil

The lubricating oil has a critical effect on the performance and service life of a rotary screw air compressor. If incorrect lubricating oil is used, it will cause severe damage to the compressor.

The compressor is supplied pre-filled with mineral based, ISO 46 grade, premium quality compressor oil that has an operating life of up to 2,000 hours under normal conditions having an air end discharge temperature of $\leq 100^{\circ}\text{C}$.

Premium quality compressor oil from other reputable manufacturers may be substituted.

It is permissible to use mineral based, semi-synthetic or full synthetic compressor oils, but they should NEVER be mixed. If changing between these different types of compressor oil, follow the flushing procedure as recommended by the oil manufacturer.

It is always best to stick with one brand and type of compressor oil from the first oil change onwards.

Notwithstanding the same reference to 'ISO 46 grade', never use hydraulic oil in place of compressor oil. Hydraulic oil does not have the same additives as those blended into compressor oil, notably for anti-foaming, and this will cause the compressor to malfunction.

5.1.1 Oil Change Interval

- a. The initial oil change should be performed after the compressor operates for about 500 running hours or 3 months, whichever occurs first.
- b. If mineral-based lubricating oil is used, it should be replaced every 1,000 to 2,000 hours. If synthetic-based oil is used, it should be replaced every 4,000 to 8,000 hours. In either case, the lubricating oil should be replaced at least every 12 months if not sooner according to the running hours limit.
- c. If an oil sample analysis indicates that the lubricating oil needs to be changed, it should be done promptly.
- d. If the operating conditions are poor and the air end discharge temperature is often 95°C or

higher, the oil change period should be halved.

5.1.2 Replacing Oil

- a. Press the Stop button  and then switch off, isolate and tag-out the power supply to the compressor.
- b. Close the air outlet valve.
- c. Wait at least two minutes for the pressure in the air-oil receiver to be completely released and monitor its pressure gauge to confirm. Slowly open the screw-plug at the oil filling port and then rotate the air end pulley by hand about 10 turns in the forward direction as marked on the air end.
- d. Remove the plug from the outlet of the oil drain ball valve and then open the valve to drain out the lubricating oil from the air-oil receiver. Collect the drained lubricating oil in a suitable container and properly dispose of it to prevent any environmental pollution.
- e. Close the oil drain ball valve and reinstall the oil drain plug. Fill the air-oil receiver with fresh lubricating oil until the oil level reaches the high ('H') limit red line on the oil level gauge as shown in Figure 5-1. Reinstall and tighten the screw-plug in the oil filling port.
- f. Restart the compressor and allow it to operate in loading mode until the discharge temperature reaches at least 71°C (for 8 or 10 bar configuration) or 83°C (for 13 bar configuration). When running in loading mode, the oil level should stabilise in between the low ('L') limit yellow line and medium ('M') green line levels. Top-up the oil level as required and do not overfill it.
- g. Reset the 'Lube Used' hours to zero via the user parameters menu on the controller.

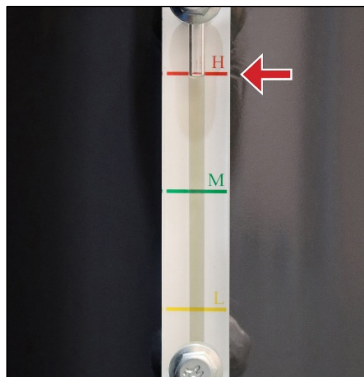



Figure 5-1: Full Oil Level Indication

5.2 Oil Filter

Initial replacement of the oil filter should be performed after the compressor operates for 500 hours or 3 months, whichever occurs first. Subsequent replacement is required every

1,000 hours or 12 months. If the lubricating oil needs to be replaced, the oil filter should be replaced at the same time. If the operating conditions are poor and the discharge temperature is often 95°C or higher, the oil filter replacement period should be halved.

The replacement steps are as follows:

- a. Press the Stop button  and then switch off, isolate and tag-out the power supply to the compressor.
- b. Close the air outlet valve.
- c. Wait at least two minutes for the pressure in the air-oil receiver to be completely released and monitor the pressure gauge to confirm.
- d. Use an oil filter wrench to remove the oil filter by unscrewing it anticlockwise.
- e. Clean the sealing washer of the new oil filter and then apply a thin layer of clean lubricating oil onto it.
- f. Install the new oil filter by screwing it on clockwise until the sealing washer contacts the oil filter base and then tighten it by hand a further ½ to ¾ of a turn.
- g. Reset the 'Oil F Used' hours to zero via the user parameters menu on the controller.

5.3 Air-Oil Separator

The air-oil separator should be replaced after every 2,000 hours or 1 year, whichever occurs first. In a dirty or dusty environment, the replacement period should be halved. It is not possible to clean the air-oil separator element, only replacement is allowed.

If the air-oil separator is an external spin-on type, the procedure for replacing it is essentially the same as that described above for replacing the oil filter.

Caution: When removing an external spin-on type of air-oil separator, the separator connector stem may become partly or wholly unscrewed from its base. Use a spanner to check and tighten the separator connector stem if necessary, taking care not to damage its sealing O-rings.

Caution: When replacing the air-oil separator, it is essential to prevent ingress of foreign matter into the air-oil receiver.

If the air-oil separator is an internal cartridge type, it should be replaced in conjunction with replacing the compressor oil and oil filter:

- a. Drain the compressor oil and remove the oil filter.
- b. Disconnect the hose and pipes as required to enable the lid of the air-oil receiver to be removed.
- c. Remove the bolts holding-down the lid of the air-oil receiver and then lift it up and away

while taking care not to damage the oil scavenge tube that's affixed to its underside.

- d. Remove the air-oil separator element and any associated gaskets or O-rings.
- e. Inspect the internal surfaces of the air-oil receiver and wipe them clean if necessary and practicable. Also, wipe clean the top flange of the air-oil receiver and the underside of its lid.
- f. Install the new air-oil separator element and any associated gaskets or O-rings. Check that any gaskets are fitted with grounding clips or that they're made from conductive gasket material. Apply a thin layer of clean lubricating oil onto any O-rings before installation.
- g. Reinstall the air-oil receiver lid and bolts, which should be evenly tightened in a star pattern.
- h. Reconnect the hose and pipes that were removed in step (c).

After replacing the air-oil separator, reset the 'Sep Used' hours to zero via the user parameters menu on the controller.

5.4 Air Pre-Filters

The air pre-filters are accessed by pulling them off from the side(s) of the compressor cabinet. They are held in place by magnets, so no tools are required to remove them. Decals affixed to the cabinet mark the installation position(s). Refer to Figure 5-2.

Wash the pre-filters in warm, soapy water and then rinse clean. Do not use any solvents or chemical cleaners.

Shake the pre-filters to remove excess water and then blow dry using compressed air or allow to dry naturally before reinstallation. Do not operate the unit with the air pre-filters or the cabinet doors or panels removed.



Figure 5-2: Air Pre-Filters Location and Removal

5.5 Air Filter

- a. After removal from the air filter assembly and working at a distance of at least 5 m away

from the compressor, the air filter element can be blown clean from the inside to the outside using compressed air at a pressure no higher than 210 kPa. Refer to Figure 5-3. Keep the air blowing outlet more than 20 mm away from the inner surface of the filter element. After the air filter element is cleaned 3 to 4 times, it should be replaced.



Figure 5-3: Air Filter Element Cleaning

- b. Do not hit the air filter element to shake free any dust nor clean it with water or any other liquid. If the filter element is damaged, it should be replaced. If the filter element is oily or contaminated severely, no cleaning is practicable and the element should be replaced.
- c. The maximum service life of the air filter element is 2,000 hours. If the operating conditions of the compressor are adverse (i.e. dusty or dirty), then the replacement period should be halved.
- d. After replacing the air filter element, reset the 'Air F Used' hours to zero via the user parameters menu on the controller.

5.6 Oil Cooler and Air After-Cooler

If the air end discharge temperature is excessively high, the oil cooler or combined oil cooler and air after-cooler mounted at the top or side of the compressor cabinet should be blown off with clean compressed air to remove any dirt or dust. If it can't be cleaned in this manner, then wash it with a proper cleaning agent. Never use a metal wire brush or metal scraper to clean it. The finned cooler should be kept clean and free of obstructions at all times.

The inside-facing surface of the finned cooler can be accessed for cleaning or inspection via removable panels on the sides of the cooling fan plenum.

5.7 Safety Valve

Check the safety valve on the air-oil receiver regularly to verify that it's operating freely. While the receiver is pressurised to at least 650 kPa (94 psi), pull the ring on the safety valve and allow it to snap back to its normal position. If air leaks out after the ring has been released, or the valve is stuck and cannot be actuated by pulling the ring, the safety valve is faulty and must be replaced before operating the compressor.

Caution: Take care when testing the safety valve as compressed air will discharge from the valve with high velocity.

Caution: Do not tamper with the safety valve. It is designed to automatically release air if the receiver pressure exceeds the safety valve's pressure setting.

5.8 V-Belts

- a. Check the condition and tension of the V-belts, if equipped, after the compressor operates for about 500 running hours or 3 months, whichever occurs first, and thereafter each 1,000 running hours or 1 year. If correctly tensioned, a force of 40 N (4 kg) applied mid-span on a single V-belt should cause it to deflect about 8 mm ($\approx 5/16$ inch).
- b. It is essential to use replacement V-belts with the correct specifications. Replace all V-belts simultaneously and do not mix belts from different manufacturers. Also, do not mix new and used V-belts.
- c. To adjust the V-belt tension on models DSV8 to DSV15, the four bolts affixing the air end to the vertical air-end / motor mounting plate should be loosened slightly, and then the position adjusting screw should be turned to move the air end up or down as required to achieve the desired tension. After adjustment, the four bolts affixing the air end should be retightened.
- d. To adjust the V-belt tension on models DSV18 to DSV45, the four bolts holding-down the air end motor to the horizontal base plate should be loosened slightly, and then the two position adjusting screws should be turned in equal increments to move the motor away from or closer to the air end to achieve the desired tension. Take care to ensure that the motor and air end shafts are kept in parallel alignment. After adjustment, the four motor hold-down bolts should be retightened.
- e. When carrying out maintenance on the compressor, do not allow any oil or other liquid to splash onto the V-belts or pulleys to prevent belt slippage.

5.9 Motor Bearings

For models DSV8 to DSV37, the air end motor's drive end (DE) and non-drive end (NDE) bearings should be regreased every 4,000 hours or 2 years, whichever occurs first. For models DSV45 to DSV90, the service interval is 2,000 hours or 1 year, whichever occurs first. Mobil Polyrex EM grease or equivalent is recommended. Do not mix different types of grease. This maintenance task is best undertaken when the motor is still warm to allow for better dispersion of the grease.

- a. Locate the grease nipple on top of each DE and NDE bearing and also the grease drain plugs underneath (that may be offset to one side). Refer to Figure 5-4. It is often necessary to temporarily remove the motor fan cowl on the non-drive end to access these points.

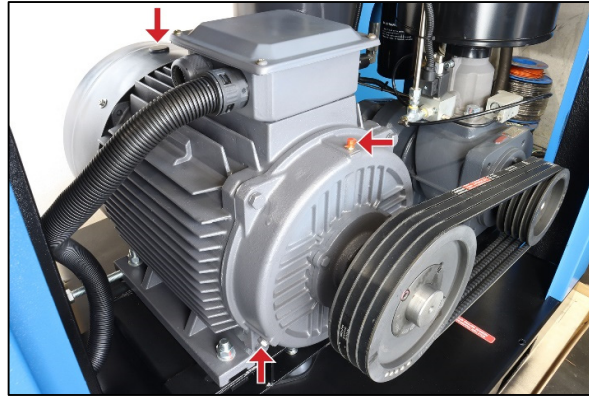

Figure 5-4: Motor Bearing Re-Greasing (NDE grease drain not shown)

- b. Remove the drain plug and clean old grease from the drain opening.
- c. Clean the grease nipple and grease gun nozzle to prevent contaminants entering the bearing.
- d. Using a hand operated grease gun, pump the requisite quantity of grease in through the nipple as specified in Table 5-1.

Table 5-1: Air End Motor Re-Greasing Data

Model	Air End Motor DE Bearing	Air End Motor NDE Bearing	Service Interval (Running Hours / Elapsed Years)	Grease Qty per Bearing (g)
DSV8	6309-C3	6309-C3	4,000 / 2	20
DSV11	6309-C3	6309-C3	4,000 / 2	20
DSV15	6309-C3	6309-C3	4,000 / 2	20
DSV18	6309-C3	6309-C3	4,000 / 2	20
DSV22	6311-C3	6311-C3	4,000 / 2	25
DSV30	6312-C3	6312-C3	4,000 / 2	25
DSV37	6312-C3	6312-C3	4,000 / 2	25
DSV45	6312-C3	6312-C3	2,000 / 1	30
DSV55	6313-C3	6313-C3	2,000 / 1	50
DSV75	6314-C3	6314-C3	2,000 / 1	50
DSV90	6314-C3	6314-C3	2,000 / 1	50

- e. Operate the compressor for 10 to 30 minutes with the drain plug removed to allow any excess grease to vent out through the drain.
- f. Shut down the compressor and make it safe to work on again. Then clean up any expelled grease from the drain outlet and re-install the plug.

5.10 Electrical Cabinet and VSD

The compressor’s electrical cabinet and the components housed therein including the VSD should be checked and cleaned by a licensed electrician every 2,000 hours or 1 year, whichever

occurs first. The external and internal surfaces of the electrical cabinet should be vacuum cleaned and wiped down with a dry cloth. The electrical components and wiring within the cabinet should be vacuum cleaned only with particular attention given to the cabinet’s louvre vents and the VSD’s cooling air vents.

5.11 Preventative Maintenance Program

Maintenance Task	Maintenance Interval *						
	8 h	40 h	500 h	1,000 h	2,000 h	4,000 h	8,000 h
	Daily	Weekly	Qtrly	1 Year		2 Years	
Routine Operation							
Check / Top-Up Oil Level	•						
Drain Air-Oil Receiver Condensate	•						
Check Controller and Gauge Readings	•						
Air System							
Clean Air Pre-Filters			•				
Clean Air Filter Element			•				
Clean Oil Cooler and Air After-Cooler			•				
Check Safety Valve				•			
Replace Air Filter Element					•		
Replace Inlet Valve Maintenance Kit							•
Replace Minimum Pressure Valve Maintenance Kit							•
Air-Oil Receiver Ext. Inspection							•
Oil System							
Replace Oil Filter			• Initial	•			
Replace Oil			• Initial		• ¹	• ²	• ³
Replace Air-Oil Separator					•		
Replace Thermostatic Valve Maintenance Kit							•
Drive System							
Check / Adjust V-Belt Tension			• Initial	•			
Replace V-Belts							•
Regrease Motor Bearings					• ⁴	• ⁵	
Electrical System							
Check Emergency Stop Button			•				
Check Electrical Connections					•		
Clean Electrical Cabinet and VSD					•		
Check Motor Insulation (> 1 MΩ)						•	

* Compressor running hours or elapsed time, whichever occurs first. In adverse working conditions, such as dusty environment and / or high temperature, the maintenance intervals should be halved.

¹ Using mineral-based compressor lubricating oil; 2,000 hours maximum or 1 year.

² Using semi-synthetic compressor lubricating oil; 4,000 hours maximum or 1 year.

³ Using fully-synthetic compressor lubricating oil; 8,000 hours maximum or 1 year.

⁴ Models DSV45 to DSV90.

⁵ Models DSV8 to DSV37.

5.12 Dismantling and Disposal

There is no requirement for the compressor to be dismantled during normal operation other than for major repair or prior to final disposal at the end of its service life. Dismantling should only be carried out by a mechanically proficient person with access to proper tools or alternatively by an authorised Senator dealer for a fee.

The air-oil receiver should be rendered unusable for pressure service prior to disposal, for example by cutting or massive deformation. This is to prevent its unauthorised and unsafe use by others.

Do not pollute the environment by improper or illegal disposal of the waste oil or condensate. Similarly, do not pollute the environment by improper or illegal disposal of the compressor either as a whole or dismantled. Take the unwanted unit or components to your local recycling centre instead. The compressor is made almost entirely of metals that can be sold to scrap metal recyclers.

6.0 Fault Diagnosis and Repair

6.1 Compressor Fault Analysis

Please refer to this section for assistance with fault diagnosis and repair in the unlikely event that any problem might occur with your air compressor.

It is important to collect operating data about the unit routinely and systematically. Based on this data, the operator can more readily detect any changes in the unit’s performance and possibly identify any potential or actual faults.

Before repairing or replacing any components, the various factors that may cause a particular fault should be investigated in detail to identify the exact reason if possible. Don’t disassemble or move the compressor unit in a disorderly way, otherwise unnecessary damage may be caused.

Routine observations should be logged of the following inspections:

- a. Whether any wiring connections and terminals are loose or disconnected.
- b. Whether any piping is damaged.
- c. Whether any components are damaged due to over-heating or short circuiting. An obvious tell-tale sign is discoloration or a burning odour.
- d. Whether any air or oil leakage is evident.
- e. Whether any abnormal noise is audible.
- f. Whether any abnormal vibration is detectable.
- g. Whether any messages or readings shown on the controller display or other gauges deviate from their regular values.

6.2 Troubleshooting Chart

Symptom	Possible Cause	Corrective Action
Compressor fails to start-up.	<ol style="list-style-type: none"> 1. Mains electricity supply is not switched on or functioning. 2. Electricity supply voltage is too low. 3. Electricity supply is not functioning on all three phases. 4. Loose wiring or poor contact. 5. Motor failure. 6. Air end failure. 	<ol style="list-style-type: none"> 1. Check mains electricity supply is switched on and live at the compressor’s incoming terminals. 2. Investigate and rectify electricity supply voltage. 3. Investigate and rectify electricity supply on all three phases. 4. Check and tighten all electrical connections. 5. Repair or replace motor. 6. Repair or replace air end.

Symptom	Possible Cause	Corrective Action
Air end discharge temperature is too high ($\geq 105^{\circ}\text{C}$).	<ol style="list-style-type: none"> 1. Insufficient lubricating oil. 2. Too high ambient temperature. 3. Oil cooler fins are blocked. 4. Oil filter is blocked. 5. Thermostatic valve is faulty. 6. Incorrect grade of lubricating oil. 7. Cooling fan is rotating backwards, has tripped its overload relay or is faulty. 8. Temperature sensor is faulty. 	<ol style="list-style-type: none"> 1. Check oil level in air-oil receiver. 2. Improve ventilation conditions and reduce room temperature. 3. Clean oil cooler fins. 4. Replace oil filter. 5. Check whether oil is cooling down via oil cooler. If not, repair or replace thermostatic valve. 6. Change to correct grade of lubricating oil. 7. Check whether cooling air is blowing up and away from the compressor. Check whether the fan motor overload relay has tripped. Repair or replace cooling fan and fan motor. 8. Check or replace temperature sensor.
Air end discharge temperature is too low ($\leq 71^{\circ}\text{C}$ for 8 or 10 bar, $\leq 83^{\circ}\text{C}$ for 13 bar).	<ol style="list-style-type: none"> 1. Very low ambient temperature. 2. Thermostatic valve is faulty. 3. Temperature sensor is faulty. 	<ol style="list-style-type: none"> 1. Change ventilation conditions and increase room temperature. 2. Repair or replace thermostatic valve. 3. Check or replace temperature sensor.
Air supply pressure (to user's air piping network) is too low.	<ol style="list-style-type: none"> 1. Pressure settings are too low. 2. Air consumption is greater than compressor output. 3. Air filter is blocked. 4. Inlet valve isn't opening fully. 5. Pressure sensor is faulty. 6. Minimum pressure valve is faulty. 7. Air-oil separator is blocked. 	<ol style="list-style-type: none"> 1. Check the controller's pressure settings. 2. Reduce air consumption or check air piping system for leakage. 3. Clean or replace air filter element. 4. Check the action of inlet valve. 5. Check or replace pressure sensor. 6. Repair or replace minimum pressure valve. 7. Check or replace air-oil separator.
Air supply pressure (to user's air piping network) is too high.	<ol style="list-style-type: none"> 1. Pressure settings are too high. 2. Air system unloading components are faulty, e.g. solenoid valve, inlet valve and vent valve. 3. Leakage in control air piping. 4. Pressure sensor is faulty. 	<ol style="list-style-type: none"> 1. Check the controller's pressure settings. 2. Check, repair or replace unloading components. 3. Check and rectify leakage. 4. Check or replace pressure sensor.
Air discharge pressure (to the air-oil receiver) is too high.	<ol style="list-style-type: none"> 1. Pressure settings are too high. 2. Air system unloading components are faulty, e.g. solenoid valve, inlet valve and vent valve. 3. Leakage in control air piping. 4. Air-oil separator is blocked. 5. Minimum pressure valve is faulty. 6. Pressure sensor is faulty. 	<ol style="list-style-type: none"> 1. Check the controller's pressure settings. 2. Check, repair or replace unloading components. 3. Check and rectify leakage. 4. Check or replace air-oil separator. 5. Repair or replace minimum pressure valve. 6. Check or replace pressure sensor.

Symptom	Possible Cause	Corrective Action
Compressed air has relatively high oil content and oil refilling period is shortened.	<ol style="list-style-type: none"> 1. Oil level in the air-oil receiver is too high. 2. Filter or orifice in the oil return pipe or the pipe itself is blocked. 3. Air-oil separator element, O-ring(s) or gasket(s) is damaged. 4. Leakage in oil piping. 5. Oil is wrong grade or type causing excessive foaming. 	<ol style="list-style-type: none"> 1. Check oil level and drain out any excess. 2. Clean or replace filter element, orifice and pipe. 3. Check or replace air-oil separator element, O-ring(s) or gasket(s) and check tightness of connections and fasteners. 4. Check and rectify leakage. 5. Replace oil with correct grade and type.
Oil mist leaks out of air filter during shutdown.	<ol style="list-style-type: none"> 1. Nil or insufficient operation in unloading mode before shutting down. 2. Solenoid valve, inlet valve or vent valve is faulty. 3. Venting of air-oil receiver is incomplete. 4. Minimum pressure valve is faulty. 	<ol style="list-style-type: none"> 1. Check and follow correct procedure for normal shut down. Check the controller's time settings 2. Check or replace solenoid valve, inlet valve or vent valve. 3. Check vent valve. 4. Repair or replace minimum pressure valve.
Switching between unloading and loading modes is too frequent.	<ol style="list-style-type: none"> 1. Air piping leakage. 2. The differential between the unload and load pressure settings is too small. 3. Air consumption and system air pressure fluctuate excessively. 4. The external compressed air receiver is too small. 	<ol style="list-style-type: none"> 1. Check and rectify air leakage. 2. Check the controller's pressure settings. 3. Increase air storage capacity in the user's piping network. 4. Install an additional or larger compressed air receiver.

7.0 Warranty

7.1 Proof of Purchase

Please complete the following details about your air compressor for future reference regarding warranty, spare parts and service.

Date Purchase:

Purchased From:

Tax Invoice Number:

Air Compressor Model Number:

Air Compressor Serial Number:

It is recommended that you keep a copy of the original tax invoice with this manual.

7.2 Warrantor

Name: Glenco Air & Power Pty Ltd
(ABN 21101370085)

Address: 21 Resource Street, Parkinson, QLD, 4115, Australia

Phone: (07) 3386 9999

Fax: (07) 3386 9988

Email: sales@glencomfg.com.au

Web: www.glencoairpower.com.au

7.3 Warranty Conditions

Glenco Air & Power Pty Ltd (the “Company”) warrants that the Goods shall be free from defects in material and workmanship for a period of twelve (12) months from the date of original sale (hereinafter the “Warranty Period”).

The Warranty Period is continuous from the date of original sale and does not re-start upon the repair or replacement of the Goods or any part thereof.

Upon return – transportation charges prepaid by the Consumer – to the Company’s or its nominated dealer’s premises within the Warranty Period, the Company shall repair or replace, at its option, any Goods which it determines to contain defective material or workmanship, and shall return said Goods to the Consumer free-on-board (FOB) at the Company’s or agent’s premises. The repair or replacement work will be scheduled and performed according to the

Company's normal work flow and availability of replacement parts.

The Company shall not be obligated, however, to repair or replace Goods which have been: repaired by others; abused; improperly installed, operated, maintained, repaired, transported or stored; not serviced to schedule using genuine spare parts; altered or otherwise misused or damaged in any way.

The Company shall not be responsible for any diagnosis, communication, dismantling, packing, handling, freight, and reassembly or reinstallation charges.

Freight damage, pre-delivery service, normal operating adjustments, preventative maintenance service, consumable items, cosmetic damage, corrosion, erosion, normal wear and tear, performance, merchantability, and fitness for a particular purpose are not covered under this Warranty. Consumable items include lubricants, filters and V-belts.

The Company shall not be liable for any repairs, replacements, or adjustments to the Goods or any costs of labour performed by the Consumer or others without the Company's prior written approval.

To the extent permissible by law and notwithstanding any other clause in these Warranty Conditions, the Company excludes all liability whatsoever to the Consumer arising out of or in any way connected with a contract for any consequential or indirect losses of any kind howsoever arising and whether caused by breach of statute, breach of contract, negligence or other tort.

The Company's liability will be limited to, in the case of products, the replacement of the products, the supply of equivalent products or the payment of the cost of replacing the products or of acquiring equivalent products or, in the case of services, the supply of the services again or the payment of the cost of having the services supplied again. The choice of remedy will be at the discretion of the Company and the Consumer acknowledges that this limitation of liability is fair and reasonable.

This Warranty is available only to the original Consumer bearing the original tax invoice from the Company or one of its authorised dealers as proof of purchase. Goods purchased from any other party such as a private seller, auction house, eBay seller, etc. are not covered by this Warranty.

Our goods come with guarantees that cannot be excluded under the Australian Consumer Law. You are entitled to a replacement or refund for a major failure and compensation for any other reasonably foreseeable loss or damage. You are also entitled to have the goods repaired or replaced if the goods fail to be of acceptable quality and the failure does not amount to a major failure.

Appendix A AIMS Controller V2.06

A1.0 Basic Operation

A1.1 Description of Controller Interface

The Air Intelligent Management System (AIMS) controller interface features a backlit LCD display and seven push-buttons as shown in Figure A1.

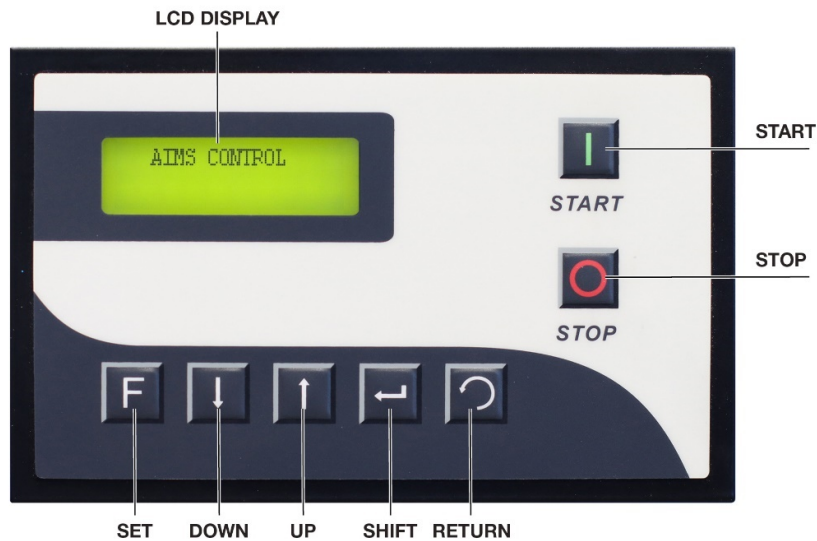







Figure A1: Front View of AIMS Controller

The screen content is always displayed whenever the compressor is energised from its electrical power supply. The screen backlight remains illuminated for one minute after initial power-up or subsequently pressing any button. The backlight makes it easier to read.

The controller must be protected from direct sunlight otherwise the LCD display will deteriorate, which is not a warrantable fault.

The primary function of each button is as follows:

-  **Start.** Press to start the compressor.
-  **Stop.** Press to stop the compressor.
-  **Set.** Press to confirm and save the input data after making a change.
-  **Down.** Press to scroll downwards or reduce a numerical value.
-  **Up.** Press to scroll upwards or increase a numerical value.

 **Shift.** Press to move the cursor to the next selection. Press and hold for three seconds to switch between local and remote control modes.

 **Return.** Press to return to an upper-level selection. Press to manually toggle between load and unload modes in between their set point pressures for troubleshooting only.

A1.2 Password Security

A four-tiered system of passwords is used to safeguard the controller’s settings and records.

The **User** password is: **1111**

The **Factory** password is made available to compressor service technicians upon request.

The **Hardware** password is reserved for use by the manufacturer.

The **Toll** password is made available to owners upon request if they want to preset an allowable block of total run time after which the compressor will not operate.

A1.3 Controller Screens Map

A hierarchical systematic view of the interface screens that are accessible via the controller is shown in Figure A2.

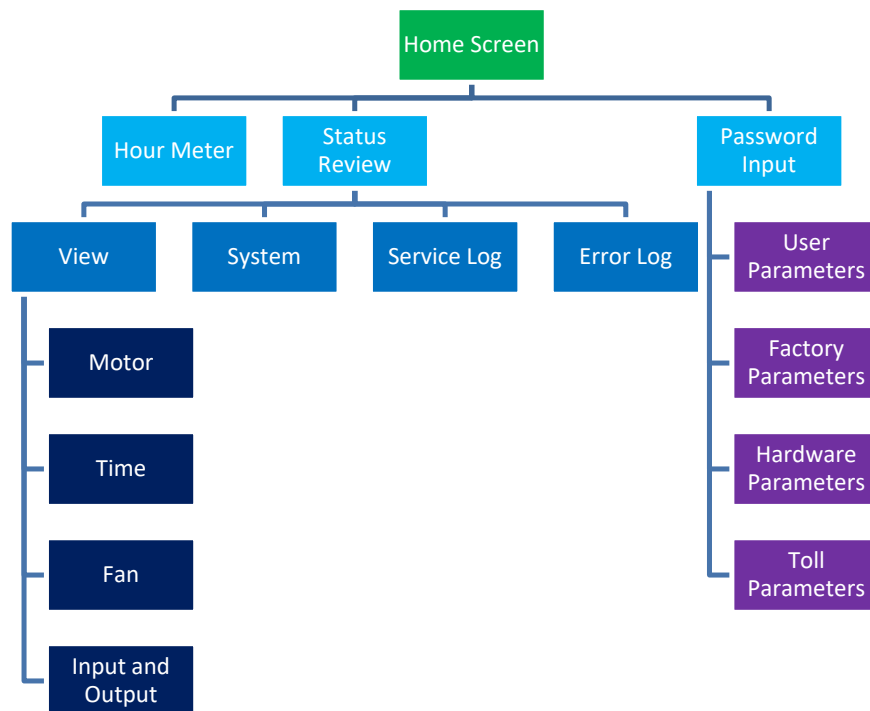

Figure A2: Controller Screens Map

A2.0 Controller Screens

A2.1 Home Screen

Five seconds after initial power-up, the home screen commences being displayed as per Figure A3. It shows the current operating status of the compressor.

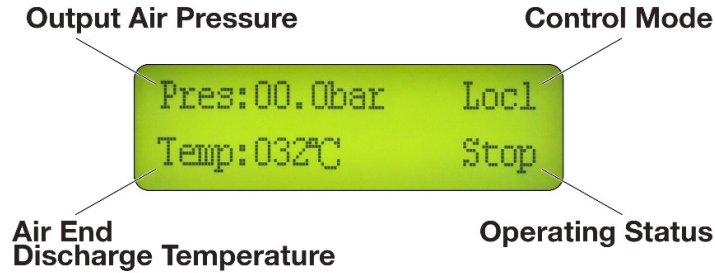

Figure A3: Home Screen

The control mode status descriptors are either ‘Locl’ for local or ‘Remt’ for remote. Local control is the standard configuration.

The operating status descriptors are explained in Table A1.

Table A1: Operating Status Descriptions

Status Indication	Description
AutoStop	The compressor has been running continuously in unloading mode for longer than the preset maximum and has shut down automatically and gone into standby mode. It will restart automatically if the air pressure drops to the load pressure setting.
Contact	The compressor requires maintenance. Please contact your local authorised Senator compressor technician, whose phone number may be viewed on the controller’s system screen page.
E-Stop	The Emergency Stop button has been pressed. When safe to do so, the compressor can be restarted manually after any fault condition has been rectified and the Emergency Stop button has been released.
Fqc: ***%	The operating speed of the compressor when running, expressed as a percentage of the maximum value.
Loading	The compressor is running automatically in loading mode.
Starting	The compressor has started running from a standstill and will automatically enter loading mode when required
Stop	The compressor is shut down and can only be started by pressing the Start button.
StpDelay	The Stop button has been pressed while the compressor was running and the unit will automatically shut down.
Unload	The compressor is running automatically in unloading mode after having reached the unload pressure setting.

If an operation or maintenance warning alarm is active, it will be indicated on the home screen

alternately with the operating status. The alarm indication will self-extinguish when the warning condition no longer exists. The warning alarm descriptors are explained in Table A2.

Table A2: Warning Alarm Messages

Warning Message	Description	Action Required
AirFLife	The air filter service life has expired.	Replace the air filter and then reset the Air F Used value in the user parameters to 0000 H.
BeltLife	The V-belts service life has expired.	Replace the V-belts and then reset the Belt Used value in the user parameters to 0000 H.
GrsLife	The motor bearing grease service life has expired.	Regrease the motor bearings and then reset the Grease Used value in the user parameters to 0000 H.
HighTemp	Air end discharge temperature too high.	Check ventilation conditions, oil cooler external cleanliness, cooling fan operation, oil level, controller parameters and thermostatic valve operation.
LubeLife	The lubricating oil service life has expired.	Replace the lubricating oil and then reset the Lube Used value in the user parameters to 0000 H.
OilFLife	The oil filter service life has expired.	Replace the oil filter and then reset the Oil F Used value in the user parameters to 0000 H.
SepLife	The air-oil separator service life has expired.	Replace the air-oil separator and then reset the Sep Used value in the user parameters to 0000 H.

If a shutdown alarm is active, it will be indicated on the home screen continuously in place of the operating status. The shutdown alarm descriptors are explained in Table A3.

Table A3: Shutdown Alarm Messages

Warning Message	Description	Action Required
FanOverload	Fan motor current overload (if equipped).	Check mains power supply on all three phases, cooling fan function, and controller parameters.
HighDischTemp	Air end discharge temperature too high.	Check ventilation conditions, oil cooler external cleanliness, cooling fan operation, oil level, controller parameters and thermostatic valve operation.

Warning Message	Description	Action Required
LowTemp	Air end discharge temperature too low.	Wait for the ambient temperature to increase naturally or use a heater. Provide weather protection against freezing conditions.
PressureHigh	Over pressure.	Check discharge air pressure, pressure sensor and controller parameters.
PSensorError	Pressure sensor failure.	Check pressure sensor and its wiring.
TSensorError	Temperature sensor failure.	Check temperature sensor and its wiring.
VarFault	Variable speed drive (VSD) failure.	Switch off mains power supply for five minutes to reset the VSD and then restart the compressor, repeat three times if necessary. Check controller parameters, mains power supply on all three phases, electrical power and control wiring, VSD parameters and any fault messages on the VSD control panel.
VoltHighStop	Electricity supply over voltage.	Check mains power supply on all three phases and controller parameters.
VoltLowStop	Electricity supply under voltage.	Check mains power supply on all three phases and controller parameters.

Press and then release unlock the Emergency Stop button after rectifying a fault to clear the shutdown alarm message and return to the normal home screen view. Depending on the fault, it may be necessary to switch the mains power supply off for five minutes to reset the VSD.

A2.2 Hour Meter Screens

While the home screen is displayed, press the Up button to view the first of the hour meter screens as shown in Figure A4.

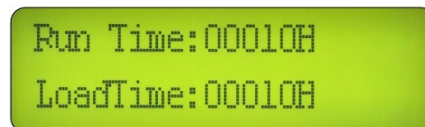

Figure A4: Hour Meter Screen – Page 1

The total accumulated running time of the compressor and the total accumulated time that the compressor has been running in loading mode are indicated.

Press the Return button to go back to the home screen.

A2.3 Status Review Screen

While the home screen is displayed, press the Down button to access the status review menu screen as shown in Figure A5.



Figure A5: Status Review Screen

Use the Up and Down buttons to position the diamond symbol ‘◆’ beside one of the four options and then press the Shift button to enter that selection.

A2.3.1 View Screen

This screen presents another menu selection of four options as shown in Figure A6.



Figure A6: View Menu Screen

Use the Up and Down buttons to position the diamond symbol ‘◆’ beside one of the options and then press the Shift button to enter that selection.

The content that can be viewed – but not edited – in each of the view screen sub-menus is listed in Table A4.

Table A4: View Screen Content

Sub-Menu Screen	Display	Description
Mtr	Freq: *** Hz	Air end motor electricity supply frequency (from the VSD).
	Powe: *** kW	Air end motor electricity supply power.
	A: *** A	Air end motor electricity supply current.

Sub-Menu Screen	Display	Description
	V: 000 V	n/a. The mains supply voltage is monitored and protected against abnormal conditions by the VSD.
Time	Run Time: ***** H	Total accumulated running time of the compressor.
	Load Time: ***** H	Total accumulated time that the compressor has been running in loading mode.
Fan	Ph A: 00.0 A	n/a. If so equipped, the fan motor current is monitored and protected against overload by a motor protection circuit breaker.
	Ph B: 00.0 A	As above.
	Ph C: 00.0 A	As above.
IO	In : *****	Input communication port status.
	Out : *****	Output communication port status.

A2.3.2 System Screen

Selecting ‘Sys’ on the status and parameter review screen allows you to view – but not edit – the system parameters listed in Table A5. Use the Up and Down buttons to scroll through the displayed content.

Table A5: System Screen Content

Display	Description
Start Tim: ** S	Air end motor starting time in star connection.
High Temp: *** °C	Maximum air end discharge temperature at or above which a shutdown alarm will be activated.
Low Temp: *** °C	Minimum air end discharge temperature at or below which a shutdown alarm will be activated.
Unload P: *.* bar	Compressor will commence unloading operation at or above this pressure.
Load P: *.* bar	Compressor will commence loading operation at or below this pressure.
Fan Start: *** °C	Electric cooling fan, if equipped, will start at or above this air end discharge temperature.
Fan Stop: *** °C	Electric cooling fan, if equipped, will stop at or below this air end discharge temperature.

Display	Description
Auto Stop: ** Min	Maximum continuous time that the compressor will operate in unloading mode before automatically shutting down and entering standby mode.
Baudrate: ***** Bps	Data communication speed setting.
Unit No.: **	Communication address.
CommMode: FREE / SLAVE	Communication mode setting.
Seq. Start: *** S	Time delay between successive start or load commands from the master controller to other compressor(s) in an interconnected group.
Seq. Uload: *** S	The time delay between successive stop or unload commands from the master controller to other compressor(s) in an interconnected group.
Seq. Turns: *** H	Run-time polling interval for interconnected compressors.
CCID:	n/a
IMEI:	n/a
LONG: ***.*****	n/a
LAT: ***.*****	n/a
HW Ver: V*. **	Controller hardware version.
SW Ver: V*. **	Controller software version.
Update: *****	Controller software date.
Tel: *****	Phone number for compressor maintenance support.

A2.3.3 Service Log Screen

Selecting ‘Svc’ on the status and parameter review screen allows you to view – but not edit – the service log data listed in Table A6. Use the Up and Down buttons to scroll through the displayed content.

Table A6: Service Log Screen Content

Display	Description
AirF Use: ***** H	Run time since the air filter was last replaced.
AirF Rmn: ***** H	Run time remaining until the air filter should be replaced.
OilF Use: ***** H	Run time since the oil filter was last replaced.
OilF Rmn: ***** H	Run time remaining until the oil filter should be replaced.
Sep Use: ***** H	Run time since the air-oil separator was last replaced.
Sep Rmn: ***** H	Run time remaining until the air-oil separator should be replaced.
Lube Use: ***** H	Run time since the lubricating oil was last replaced.
Lube Rmn: ***** H	Run time remaining until the lubricating oil should be replaced.
Grease Use: ***** H	Run time since the air end motor was last regreased.

Display	Description
Grease Rmn: ***** H	Run time remaining until the air end motor should be regreased.
Belt Use: ***** H	Run time since the V-belts were last replaced.
Belt Rmn: ***** H	Run time remaining until the V-belts should be replaced.

A2.3.4 Error Log Screen

Selecting ‘Err’ on the status and parameter review screen allows you to view – but not edit – the error log data listed in Table A7. Use the Up and Down buttons to scroll through the displayed content.

Table A7: Error Log Screen Content

Display	Description
Err 0: *****	Shutdown alarm message as per Table A3.
Time 0: ***** H	Run time at which Error 0 occurred.

... ↓

Err 9: *****	Shutdown alarm message as per Table A3.
Time 9: ***** H	Run time at which Error 9 occurred.

A total of 10 error conditions labelled Err 0 to Err 9 are stored for view on the error log screen. These are presented in reverse chronological order with Error 0 being the newest (most recent) event and Err 9 being the oldest.

A2.4 Password Input Screen

While the home screen is displayed, press the Set button to access the password input screen as shown in Figure A7.

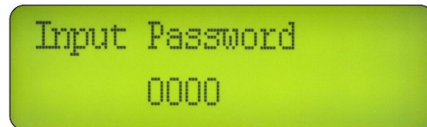

Figure A7: Password Input Screen

Use the Up, Down and Shift buttons to enter the User, Factory, Hardware or Toll Limit password and then press the Set button to proceed to the related screen(s).

A2.4.1 User Parameter Screens

After keying-in the User password on the password input screen, the user parameter menu

screen menu will appear as shown in Figure A8.



Figure A8: User Parameter Menu Screen

Use the Up and Down buttons to position the diamond symbol ‘◆’ beside one of the menu options and then press the Shift button to enter that selection.

The Up and Down buttons can then be used to scroll through the user parameters in each of the Operation (‘Oper’), Time and Service (‘Svc’) sub-menus.

The user parameters have been pre-programmed in accordance with Table A8 and should NOT be changed without reference to the manufacturer.

If necessary, a user parameter value can be changed by selecting it using the Shift button and then modifying it using the Up, Down and Shift buttons. Finally, the change can be locked-in by using the Set button.

Table A8: User Parameters

Menu	Parameter	Set Value	Function
Oper	Unload P	8.0 bar or 10.0 bar or 13.0 bar	The compressor will commence unloading operation at or above this pressure. Use the lower value for standard 8 bar maximum pressure configuration. Use one of the higher values for optional 10 or 13 bar configuration. #
	Load P	7.0 bar or 9.0 bar or 12.0 bar	The compressor will commence loading operation at or below this pressure. Use the lower value for standard 8 bar maximum pressure configuration. Use one of the higher values for optional 10 or 13 bar configuration. #
	Fan Start	83 °C or 90 °C	The electric cooling fan, if equipped, will start at or above this air end discharge temperature. Use the lower value for 8 bar pressure configuration. Use the higher value for 10 or 13 bar configuration.

Menu	Parameter	Set Value	Function
	Fan Stop	71 °C or 80 °C	The electric cooling fan, if equipped, will stop at or below this air end discharge temperature. Use the lower value for 8 bar pressure configuration. Use the higher value for 10 or 13 bar configuration.
	Comm Mode	SLAVE	Use 'SLAVE' for standalone compressor. Use 'FREE' for each dependent compressor in an interconnected group.
	Unit No.	01	Communication address. Use 01 for a standalone compressor or master compressor in an interconnected group. Use 02 ~ 08 for a slave compressor in an interconnected group. Note that each slave unit must be assigned a unique Unit No. in ascending numerical order.
	High Fre	50 or 43	Maximum power supply frequency from the VSD to the air end motor. Use the lower value only for models DSV55 ~ 90 in 10 bar configuration. Use the higher value for all other models and configurations.
	Low Fre	20	Minimum power supply frequency from the VSD to the air end motor.
	Target P	7.5 bar or 9.5 bar or 12.5 bar	The compressor will automatically adjust the air end speed to maintain this pressure set point. This value cannot be set outside the range between the load and unload pressures. The lower the VSD pressure set point, the less energy is consumed by the unit. Use the lower value for standard 8 bar maximum pressure configuration. Use one of the higher values for optional 10 or 13 bar configuration. #
	Language	ENG	Set ENG for English language.
	Password	1111	Use only the specified set value for access to the user parameters.
	Ctrl Mode	AUTO	Use only the specified set value for the control mode.
	Pres Unit	bar	Pressure unit of measure.
	Temp Unit	°C	Temperature unit of measure.
Time	Start Time	5 S	Air end motor starting time allowance.
	Load Delay	5 S [DSV8~15] 8 S [DSV18 ~ 90]	Loading delay time. Loading mode operation will not commence until this time plus the Start Time has elapsed.

Menu	Parameter	Set Value	Function
	Auto Stop	5 Min	Maximum continuous time in unloading mode. The compressor will automatically stop after this time and enter standby mode.
	Stop Time	30 S	After pressing the Stop button, the compressor will not stop running until this time has elapsed in unloading mode.
	Seq. Start	30 S	The time delay between successive start or load commands from the master controller to other compressor(s) in an interconnected group.
	Seq. Uload	30 S	The time delay between successive stop or unload commands from the master controller to other compressor(s) in an interconnected group.
	Seq. Turns	100 H	Run time polling interval for compressors in an interconnected group.
Svc	Air F Life	2000 H	Air filter replacement interval.
	Oil F Life	1000 H	Oil filter replacement interval.
	Sep Life	2000 H	Air-oil separator replacement interval.
	Lube Life	2000 H	Oil change interval.
	Grease Life	4000 H [DSV8~37] 2000 H [DSV45~90]	Motor bearing regrease interval.
	Belt Life	8000 H	V-belts replacement interval.
	Air F Used	**** H	Run time since the air filter was last replaced. Reset to 0000 after replacement.
	Oil F Used	**** H	Run time since the oil filter was last replaced. Reset to 0000 after replacement.
	Sep Used	**** H	Run time since the air-oil separator was last replaced. Reset to 0000 after replacement.
	Lube Used	**** H	Run time since the lubricating oil was last replaced. Reset to 0000 after replacement.
	Grease Used	**** H	Run time since the air end motor was last regreased. Reset to 0000 after regreasing.
	Belt Used	**** H	Run time since the V-belts were last replaced. Reset to 0000 after replacement.

For models DSV8 to DSV45: DO NOT enter the 10 or 13 bar maximum pressure parameters without also changing the compressor’s air end speed by replacing certain V-belt drive components. For 13 bar configuration, the thermostatic valve element must also be replaced. Refer to the Specifications.

For models DSV55-8-10 ~ DSV90-8-10, DO NOT enter the 10 bar maximum pressure

parameters unless the VSD parameters have been changed accordingly. These models cannot be changed to 13 bar configuration because of their direct-coupled gear drive design.

Models DSV55-13 ~ DSV90-13 are supplied from the factory in 13 bar maximum pressure configuration.

A2.4.2 Factory Parameter Screens

After keying-in the Factory password on the password input screen, the first of 14 factory parameter screens will appear as shown in Figure A9.



Figure A9: Factory Parameter Menu Screen No. 1 of 14

Use the Up and Down buttons to position the diamond symbol ‘◆’ beside one of the parameters and then press the Shift button to enter that selection. If necessary, the parameter value can be changed by using the Up, Down and Shift buttons. Finally, the change can be locked-in by using the Set button.

The Up and Down buttons can also be used to scroll through all 14 of the factory parameter screens.

The factory parameters have been pre-programmed in accordance with Table A9 and should NOT be changed without reference to the manufacturer. It is unlikely that any of the factory parameters would need to be changed during the life of the air compressor set after dispatch from the manufacturer.

Table A9: Factory Parameters

Parameter	Set Value	Function
Main I	16 A [DSV8] 24 A [DSV11] 32 A [DSV15] 37 A [DSV18] 44 A [DSV22] 60 A [DSV30] 74 A [DSV37] 92 A [DSV45] 112 A [DSV55] 152 A [DSV75] 182 A [DSV90]	n/a. The set value is entered for reference only. The air end motor current is monitored and protected against abnormal conditions by the VSD.

Parameter	Set Value	Function
Main V	400 V	n/a. The set value is entered for reference only. The mains supply voltage is monitored and protected against abnormal conditions by the VSD.
Volt High	110 %	As above.
Volt Low	94 %	As above.
Fan I	0.0 A [DSV8] 0.0 A [DSV11] 0.0 A [DSV15] 1.6 A [DSV18] 1.6 A [DSV22] 2.2 A [DSV30] 2.2 A [DSV37] 3.2 A [DSV45] 5.0 A [DSV55] 5.0 A [DSV75] 7.2 A [DSV90]	n/a. The set value is entered for reference only. If so equipped, the fan motor current is monitored and protected against overload by a motor protection circuit breaker.
High Temp	110 °C	A shutdown alarm will be activated if the air end discharge temperature reaches up to this set value.
Warn Temp	105 °C	A warning alarm will be activated if the air end discharge temperature reaches up to this set value.
H P Bias	00.5 bar	A shutdown alarm will be activated if the discharge air pressure reaches the total of this value plus (a) the unload pressure setting or (b) the maximum allowable unload pressure setting, whichever is lower.
P Limit	8.0 bar or 10.0 bar or 13.0 bar	The maximum allowable unload pressure setting. Use the lower value for standard 8 bar maximum pressure configuration. Use one of the higher values for optional 10 or 13 bar configuration.
Load Time	***** H	Total accumulated time that the compressor has been running in loading mode. Do not change it.
Run Time	***** H	Total accumulated running time of the compressor. Do not change it.
Overload Time	00 Min	n/a. This function is inactive.
Fan Ctrl	OFF [DSV8 ~ DSV15] ON [DSV18 ~ DSV90]	Controls the fan motor operation function.
V Check	OFF	n/a. This function is inactive.
I Check	OFF	n/a. This function is inactive.
Svc Expir	0000 H	Allowable run time limit with an active maintenance warning alarm. Set the value to 0000 H to disable this function.
V/I Fan	FAN	n/a. This function is inactive.

Parameter	Set Value	Function
Restart	01 Min	The compressor cannot be restarted before this time has elapsed after being either manually or automatically shut down.
Ct Ratio	100	Current transformer ratio.
Ctrl Valv	NO	Control valve type.
P Sns Type	16.0 bar	Pressure sensor type.
Low Temp	0 °C	A shutdown alarm will be activated if the air end discharge temperature reaches down to this set value.
Tel	*****	Phone number for compressor maintenance support.
Grease Serv	ON	Controls the motor bearing regrease maintenance alarm function.
Pow Type	3 PHASE	Selects that the electrical power supply is three-phase.
Phase Cir	OFF	n/a. This function is inactive.
Fan Stop Delay	00 Min	Fan run-on delay time.
P Restart	00 S	Automatic restart after blackout delay time. Set to the value to 00 S to disable this function. DO NOT activate this function without implementing risk controls because there is no local alarm or annunciation warning of the compressor's auto restart.
M Factor	0.80	Nominal air end motor power factor.
FactPass	****	Factory password. Do not change it.

A2.4.3 Hardware Parameter Screens

After keying-in the Hardware password on the password input screen, the first of 16 hardware parameter screens will appear as shown in Figure A10.

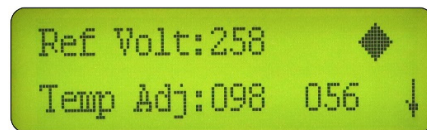

Figure A10: Hardware Parameter Menu Screen No. 1 of 16

Use the Up and Down buttons to position the diamond symbol ‘◆’ beside one of the parameters and then press the Shift button to enter that selection. If necessary, the parameter value can be changed by using the Up, Down and Shift buttons. Finally, the change can be locked-in by using the Set button.

The Up and Down buttons can also be used to scroll through all 16 of the hardware parameter screens.

The hardware parameters have been pre-programmed in accordance with Table A10 and should

NOT be changed without reference to the manufacturer. It is unlikely that any of the hardware parameters would need to be changed during the life of the air compressor set after dispatch from the manufacturer.

Table A10: Hardware Parameters

Parameter	Set Value	Description
Ref Volt	259 [for 415 V mains supply] 250 [for 400 V mains supply]	Controller supply voltage. Adjust it to match that measured by an accurate test voltmeter, e.g. set to '257' for 25.7 V AC.
Temp Adj	100	Temperature sensor calibration coefficient. Adjust it so that the displayed air end discharge temperature equals the ambient temperature. Perform only after 12 hours minimum stop time.
Press Adj	100	Pressure sensor calibration coefficient. Adjust it so that the displayed discharge pressure equals that measured by an accurate test pressure gauge.
Volt Adj	100	Internal voltmeter calibration coefficient. Adjust it so that the displayed mains power supply voltage equals that measured by an accurate test voltmeter.
M I A Adj	100	Internal ammeter calibration coefficient for the air end motor supply A-phase. Adjust using an accurate test ammeter.
M I B Adj	100	Internal ammeter calibration coefficient for the air end motor supply B-phase. Adjust using an accurate test ammeter.
F I A Adj	100	Fan motor equivalent to 'M I A Adj' above.
F I B Adj	100	Fan motor equivalent to 'M I B Adj' above.
Vf Contr	ON	Activates VSD control functionality.
Feq Addr	00002	Use only the specified set value.
Feq Rate	1/100	Use only the specified set value.
Curr Addr	00003	Use only the specified set value.
Curr Rate	1/010	Use only the specified set value.
Power Add	00020	Use only the specified set value.
Power Rat	1/010	Use only the specified set value.
Give Addr	08193	Use only the specified set value.

Parameter	Set Value	Description
Give Min	00000	Use only the specified set value.
Give Max	05000	Use only the specified set value.
Input 00	000	Use only the specified set value.
Input 01	008	Use only the specified set value.
Input 02	009	Use only the specified set value.
Input 03	003	Use only the specified set value.
M I R	013	Use only the specified set value.
M I T	007	Use only the specified set value.
F I R	255	Use only the specified set value.
F I T	255	Use only the specified set value.
Volt V	255	Use only the specified set value.
! In	0000000000	Use only the specified set value.
Ex Module	00	Use only the specified set value.
Dry Control	OFF	Use only the specified set value.
Test Mod	OFF	Use only the specified set value.

A2.4.4 Toll Parameter Screens

After keying-in the Toll password on the password input screen, the first of two toll parameter screens will appear as shown in Figure A11.



Figure A11: Toll Parameter Menu Screen No. 1 of 2

Use the Up and Down buttons to position the diamond symbol ‘◆’ beside one of the parameters and then press the Shift button to enter that selection. If necessary, the parameter value can be changed by using the Up, Down and Shift buttons. Finally, the change can be locked-in by using the Set button.

The Up and Down buttons can also be used to scroll through both of the toll parameter screens.

The toll parameters have been pre-programmed in accordance with Table A11 and should NOT be changed without reference to the manufacturer. It is uncommon that any of the toll parameters would need to be changed during the life of the air compressor set after dispatch from the manufacturer.

Table A11: Toll Parameters

Parameter	Set Value	Function
Owed Stop	OFF	Controls the preset run time limit function.
Owed Stop Time	1000 h	Preset run time limit. If the Owed Stop parameter is set to 'ON', the compressor will not operate after this limit has been exceeded. The set value range is 500 ~ 9999 h.
Clear Err History		Press the Set button to clear the error log and reset the run time counter for the preset run time limit function.

Appendix B Variable Speed Drive

B1.0 General Description

B1.1 Introduction

The compressor is equipped with ZONCN H3000 Series Variable Speed Drive (VSD). The VSD uses sophisticated control technology to vary the compressor drive motor's speed in response to fluctuating compressed air demand.



Figure B1: ZONCN H3000 Series Variable Speed Drive

In simple terms, the VSD is connected to the mains alternating current (AC) electrical power supply that has both constant voltage and frequency, i.e. ≈ 400 Volts and 50 Hertz. The VSD firstly converts the input AC power into direct current (DC) power. It then inverts this DC power back to AC power, but with variable voltage and frequency to control the speed of the compressor's AC drive motor as instructed by the AIMS Controller.

The VSD has been programmed by the compressor manufacturer and extensively test run. It is configured for fully automatic operation and receives its operating commands from the AIMS Controller. Under normal conditions, DO NOT touch the VSD other than for cleaning as described hereunder.

B1.2 Special Precautions

The VSD is located inside the compressor's cabinet where there is a danger of high voltage. The compressor cabinet should only be opened by a licensed electrician unless the mains power supply has been switched off, isolated and tagged out, and a subsequent delay of 10 minutes has been allowed for the VSD's capacitors to fully discharge.

It is recommended that inspection and cleaning of the VSD's external and internal components be carried out at no less than yearly intervals.

There are highly sensitive metal oxide semiconductor ('MOS') components on the printed circuit boards. These components are especially sensitive to static electricity. Do not touch these components or the circuit boards without taking anti-static precautions. Never reassemble

internal components or wiring. Remove any personal metal objects such as watches and rings before carrying out any maintenance on the VSD and use only insulated tools.

Ensure that the compressor and the VSD are electrically earthed. The VSD is equipped with an earth terminal for this purpose. Do not connect the VSD output terminals U, V and W to the mains power supply.

The compressor should not be installed in an environment where it's exposed to chemicals, dust, dirt, fibres, moisture, oil, salt, or flammable or explosive liquids or gases. These pollutants may damage the electronic and high voltage components within the VSD and cause it to burn out or explode.

If the VSD is stored without use for more than three months, the ambient temperature should not be higher than 30°C. Storage for longer than one year is not recommended as it could result in degradation of the electrolytic capacitors.



B1.3 Control Panel









The VSD's control panel is shown in Figure B2. The functionality of the keys, control knob and LED indicators (when lit) is described in Table B1.



Figure B2: Control Panel

Table B1: Control Panel Button, Rotary Knob and LED Functions

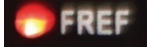
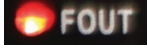
Item	Description
	Program. Press to select and use function menu.
	Up. Press to scroll upwards or increase a numerical value.
	Down. Press to scroll downwards or decrease a numerical value.

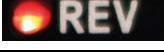
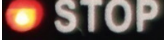
Item	Description
	Enter. Press to move the cursor to the next selection. Press and hold to confirm and save the input data after making a change. Press to select different screen displays.
	Forward. Press to select forward rotation option. This functionality has been disabled.
	Reverse. Press to select reverse rotation option. This functionality has been disabled.
	Stop Reset. Press to stop the VSD, which functionality has been disabled. Press to reset a fault alarm.
	Rotary Push Knob. Push to select different screen displays.
	DRV. The VSD is in running mode.
	RDY. The VSD is in standby mode.
	FREF. The screen is displaying the setup frequency.
	FOUT. The screen is displaying the output frequency.
	IOUT. The screen is displaying the output current.
	FWD. The VSD is in forward rotation mode.
	REV. The VSD is in reverse rotation mode.
	STOP. The VSD is stopped with no output.

B1.4 Display Screen

During normal operation, the screen will display the output frequency as shown in Figure B3 when the FOUT indicator is illuminated.



Figure B3: VSD Display in Running Mode

When the compressor is running and neither the FREF, FOUT nor IOUT indicators are illuminated, the screen will display the air end motor speed (rpm) value.

When setting the VSD parameters, the screen may display other content such as:

- a. The identification number of the parameter, e.g. 'F1.05'.
- b. The set value of the parameter.
- c. 'END' to confirm that the parameter set value has been modified and confirmed successfully.
- d. 'no' to indicate that the parameter set value has not been modified.

Other messages may be displayed on the screen to indicate fault alarms. These include:

- e. 'OC*', 'OU*', 'LU*', 'Fb*', 'OL*', 'OT*' or 'OH*'.
- f. 'ES', 'CO', '20', 'Pr' or 'Err'.

Please contact your local authorised Senator service technician or the compressor manufacturer for assistance in the unlikely event that any of the above fault alarm messages are displayed.

B2.0 Parameter Setup and Operating Faults

B2.1 Parameter Review

The VSD operating parameters are preset by the manufacturer and should not normally require reviewing or changing. Any necessary adjustments to the compressor's operating parameters such as load and unload pressures, maintenance times and so on need only be entered into the AIMS Controller.

To review any of the VSD operating parameters:

- a. The mains power supply to the compressor must be switched on.
- b. The compressor must be in Stop mode and not running.
- c. Press the Program button. The screen should display 'F*****' to confirm that the VSD is in parameter setup mode.
- d. Use quick presses on the Up, Down and Enter buttons to key in the desired parameter item number, and then press and hold the Enter button for two seconds to view the current set value of this parameter.
- e. Press the Enter button again for two seconds. The screen will display 'no' briefly and then the menu will automatically revert to the next parameter item in numerical order.
- f. Repeat steps (d) and (e) as many times as required to review the parameters of interest.
- g. When finished, press the Program button to exit from the parameter review mode.

There are more than 200 operating parameters in the VSD's complete setup, however only the

33 or so parameters listed in Table B2 need to be customised or verified. All the other parameters remain unchanged from the VSD’s default settings and do not need to be verified.

Table B2: Non-Default VSD Operating Parameter Settings

Parameter	Set Value	Description
F0.00	1	Main display data selection.
F1.01	5	Frequency setting selection.
F1.02	1	Start signal selection.
F1.03	0	Stop button lock operation selection.
F1.04	0	Reverse rotation prevention selection.
F1.05	43.00 [DSV55-8-10, DSV75-8-10 & DSV90-8-10 in 10 bar configuration] or 50.00 [All other models and configurations]	Maximum frequency.
F1.06	20.00	Minimum frequency.
F1.07	10.0 [DSV8 ~ 15] 20.0 [DSV18 ~ 45] 30.0 [DSV55 ~ 90]	Acceleration time 1.
F1.08	5.0 [DSV8 ~ 15] 10.0 [DSV18 ~ 45] 15.0 [DSV55 ~ 90]	Deceleration time 1.
F1.09	400.0	V/F maximum voltage.
F1.10	50.00	V/F fundamental frequency.
F1.11	200.0	V/F intermediate voltage.
F1.12	20.00	V/F intermediate frequency.
F1.13	5.0	V/F minimum voltage.
F1.14	0.5	V/F minimum frequency.
F1.17	0	Initialization of parameters.
F1.18	1	Parameter lock.
F2.01	1	Stop mode selection.
F2.09	400.0	Rated motor voltage.
F2.10	16.0 [DSV8] 24.0 [DSV11] 32.0 [DSV15] 37.0 [DSV18] 44.0 [DSV22] 60.0 [DSV30] 74.0 [DSV37] 92.0 [DSV45] 112.0 [DSV55] 152.0 [DSV75] 182.0 [DSV90]	Rated motor current.

Parameter	Set Value	Description
F2.12	2930 [DSV8] 2930 [DSV11] 2930 [DSV15] 2930 [DSV18] 2950 [DSV22] 2950 [DSV30] 2955 [DSV37] 2970 [DSV45] 2970 [DSV55] 2975 [DSV75] 2975 [DSV90]	Rated motor rotation speed.
F2.13	2	Number of motor poles.
F2.15	50.00	Rated motor frequency.
F3.03	4.3	FIC minimum current input.
F3.04	19.8	FIC maximum current input.
F3.12	50.00	Frequency of high analog.
F3.15	6	Input terminal FWD.
F3.16	7	Input terminal REV.
F7.00	1	Communication speed.
F7.01	4	Communication mode.
F7.02	2	Communication address.
F7.03	2	Handling of communication failures.
F7.04	60.0	Time of communications timeout.

B2.4 Resetting and Re-entering the Operating Parameters

A situation may arise whereby there's doubt about whether some of the VSD's parameters have been changed from their pre-programmed settings. Or there may be a requirement to program a replacement VSD unit. In such cases, all the VSD's operating parameters should be reset to the factory default settings and then only those listed in Table B2 should be changed to the specified values.

After resetting the VSD's operating parameters to the factory default settings, the compressor will not function properly and will likely be permanently damaged if the VSD operating parameters listed in Table B2 are not set to the specified values.

To reset the VSD's operating parameters to the factory default settings and then re-enter the mandatory non-default settings:

- a. The mains power supply to the compressor must be switched on.
- b. The compressor must be in Stop mode and not running.
- c. Enter the VSD PARAMETER PROTECTION PASSWORD. This password is made available to licensed electricians upon request.
- d. Press the Program button. The screen should display 'F*****' to confirm that the VSD is in

parameter setup mode.

- e. Use quick presses on the Up, Down and Enter buttons to key in parameter item number F1.17. Then press and hold the Enter button for two seconds to view the current set value of this parameter.
- f. Use quick presses on the Up, Down and Enter buttons to key in a value of '8' for parameter F1.17 and then press and hold the Enter button for two seconds to save this change. The screen will display 'END' briefly thereby confirming the change and then the menu will automatically revert to the next parameter number in numerical order. The VSD parameters have now been reset to their original default values.
- g. Select each of the operating parameters listed in Table B2 starting from F0.00 and use the Up, Down and Enter buttons to set it to the specified value. Do this carefully one parameter at a time from top to bottom EXCEPT for F1.18, which should be left unchanged with the default value of '0' at this stage.
- h. Repeat the previous step to double-check that each of the non-default parameters has been correctly set as per Table B2 EXCEPT for F.18.
- i. Use quick presses on the Up, Down and Enter buttons to key in a value of '1' for parameter F1.18 and then press and hold the Enter button for two seconds to save this change. The screen will display 'END' briefly thereby confirming the change and then the menu will automatically revert to the next parameter number in numerical order.
- j. Press the Program button to exit from the parameter setup mode.
- k. Review the VSD parameters using the method described in Section B2.1 to triple-check that each of the non-default parameters listed in Table B2 has been correctly set. If all is OK, the VSD parameters have now been reset to the factory default values and the mandatory non-default value changes and default value verifications have been completed. The compressor can now be restarted.

B2.5 VSD Faults

In the event of a fault being detected in the VSD, the compressor will shut down automatically and annunciate 'VarFault' on the AIMS Controller display. The most likely cause of the reported fault is:

- a. Wrong controller parameter setting(s).
- b. Wiring disconnection or fault.
- c. Electrical power supply fault.
- d. Wrong VSD parameter setting(s).
- e. VSD fault.

The recommended course of action to rectify the problem is as follows:

- a. Switch off the mains electricity supply for five minutes to reset the VSD and then restart the compressor, repeating three times if necessary.
- b. Check that all the controller parameters have been correctly set.
- c. Check the electricity supply on all three phases.
- d. Check the electrical power and control wiring.
- e. Check that all the VSD parameters have been correctly set.
- f. If necessary, reset and re-enter the VSD parameters as described in the previous section.

Press and hold the Stop Reset button on the VSD's control panel for two seconds after taking each of the steps listed above to reset the fault alarm, if possible.

For safety, steps (c) to (f) above must only be undertaken by a licensed electrician.

Please contact your local authorised Senator service technician or the compressor manufacturer for further assistance if required.

Appendix C Remote Start and Stop Control

Update pending at the time of publication.

Please check the Downloads section at www.glencoairpower.com.au for the latest edition of this Instruction Manual.



Glenco Air & Power Pty Ltd ABN 21101370085 | **address** 21 Resource Street, Parkinson QLD 4115, Australia
phone 07 3386 9999 | **fax** 07 3386 9988 | **email** sales@glencomfg.com.au | **web** www.glencoairpower.com.au